

MEGAPIX Ai™

Next-generation video analytics

| |
|--------------------------------|
| DWC-XSTD05Bi - fixed lens |
| DWC-XSTD05Mi - vari-focal lens |

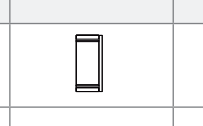
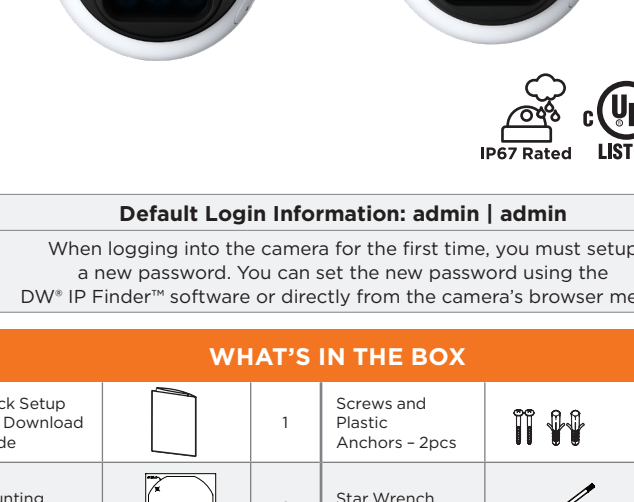

Default Login Information: admin | admin

When logging into the camera for the first time, you must setup a new password. You can set the new password using the DW® IP Finder™ software or directly from the camera's browser menu.

| WHAT'S IN THE BOX | | | | | |
|--|--|-------|-----------------------------------|--|-------|
| Quick Setup and Download Guide | | 1 | Screws and Plastic Anchors - 2pcs | | 1 set |
| Mounting Template | | 1 | Star Wrench (T10) | | 1 |
| Hexagonal wrench 2.0 | | 1 | Moisture Absorber (Recommended) | | 1 |
| Waterproof Cap and Rubber Rings (Black: ø0.15" (ø4mm), White: ø0.19" (ø5mm)) | | 1 set | | | |

NOTE: Download all your support materials and tools in one place

- Go to: <http://www.digital-watchdog.com/resources>
- Search your product by entering the part number in the "Search by Product" search bar. Results for applicable part numbers will populate automatically based on the part number you enter.
- Click "Search". All supported materials, including manuals and quick start guide (QSGs) will appear in the results.

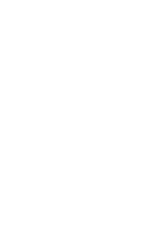

Attention: This document is intended to serve as a quick reference for the initial set-up. It is recommended that the user read the entire instruction manual for complete and proper installation and usage.

STEP 1 - PREPARING TO MOUNT THE CAMERA

- Install the Dessoric Pack (moisture absorber):
 - Remove the Dessoric Pack from its shipping packaging.
 - Using the star wrench, open the camera's control panel on the side of the camera.
 - Remove the Dessoric Pack used for shipping.
 - Place the new Dessoric Pack as shown in the illustration below.
 - Close the camera control panel tightly.

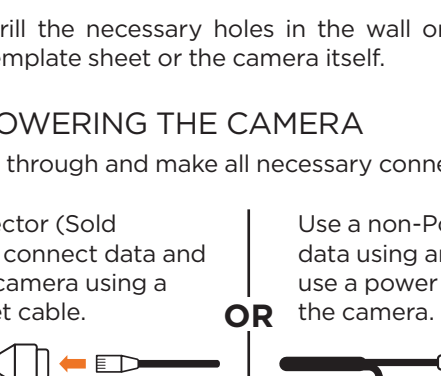

NOTE: The camera will generate enough heat to operate. In case of moisture issues, keep the moisture absorber in the camera up to 6 months.

WARNING: Install the moisture absorber when mounting the camera to prevent performance issues and damage to the camera.

- Mark and drill the necessary holes in the wall or ceiling using the mounting template sheet or the camera itself.

STEP 2 - POWERING THE CAMERA

Pass the wires through and make all necessary connections.

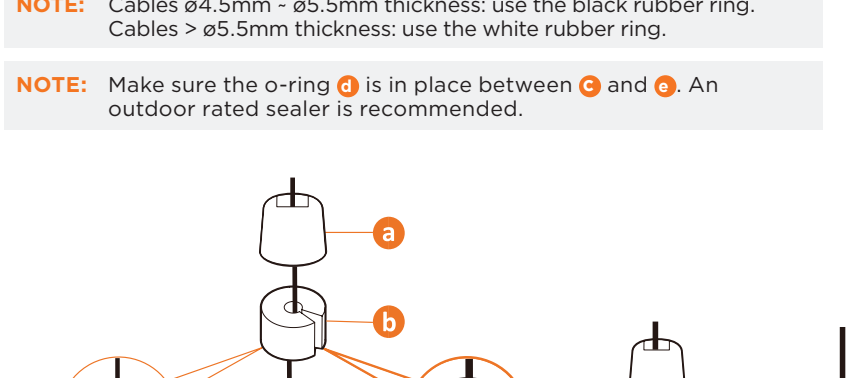

| Power information | |
|--------------------|---|
| Power requirements | DC12V, PoE (Adapter not included) |
| Power consumption | DWC-XSTD05Bi: DC: max 7.5W, 625mA, PoE: max 9.5W, 197mA DWC-XSTD05Mi: DC: max 8.5W, 708mA, PoE: max 11W, 229mA |
| Maximum distance | 328' (100m) |
| Connector | RJ45 |

WATERPROOF CAP INSTALLATION

The waterproof cap set comes with two rubber rings. Use the rubber ring best sized for your network cable's diameter.

NOTE: Cables ø4.5mm - ø5.5mm thickness: use the black rubber ring.
Cables > ø5.5mm thickness: use the white rubber ring.

NOTE: Make sure the o-ring **d** is in place between **c** and **e**. An outdoor rated sealer is recommended.

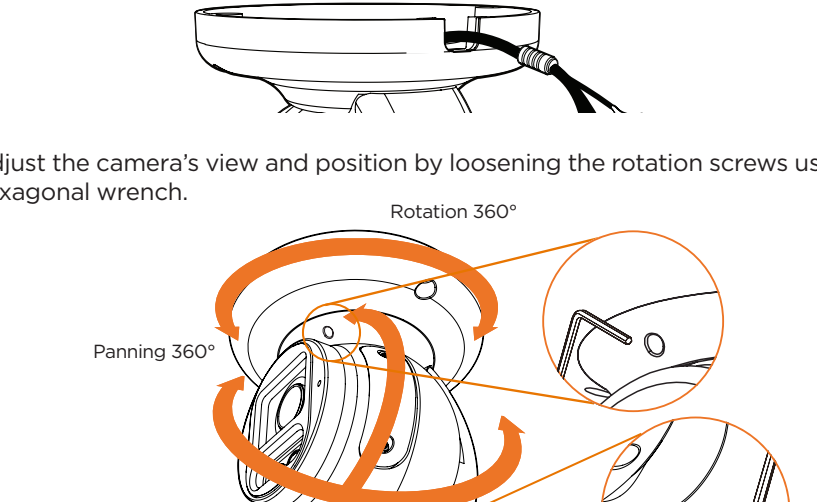

STEP 3 - INSTALLING THE CAMERA

- Secure the camera to the mounting surface using the included screws.
- Use the rubber plug on the side of the camera as a cable guide to prevent cables from getting caught between the camera and the mounting surface.

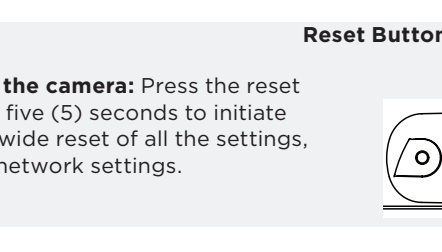

- Adjust the camera's view and position by loosening the rotation screws using the hexagonal wrench.

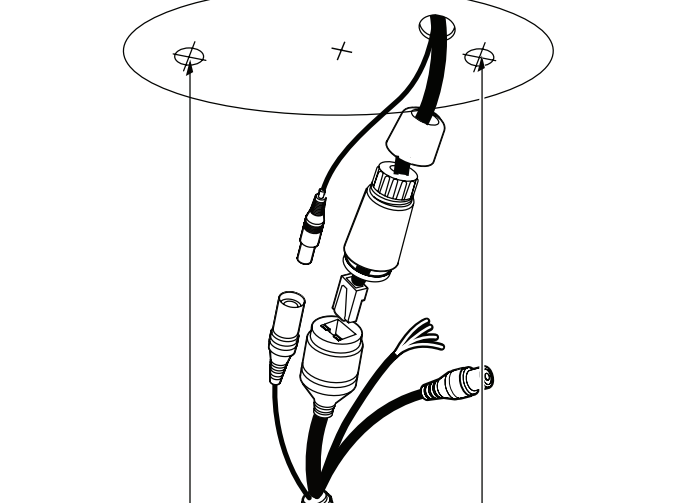

NOTE: When setting up the **DWC-XSTD05Mi** camera for the first time, use the **CALIBRATE** button on the camera's web GUI to calibrate the camera's lens before operation.

- Remove the protective film from the lens cover. Softly wipe the lens cover with lens tissue or a microfiber cloth with ethanol to remove any dust or smudges left from the installation process.

Reset Button

Resetting the camera: Press the reset button for five (5) seconds to initiate a camera-wide reset of all the settings, including network settings.

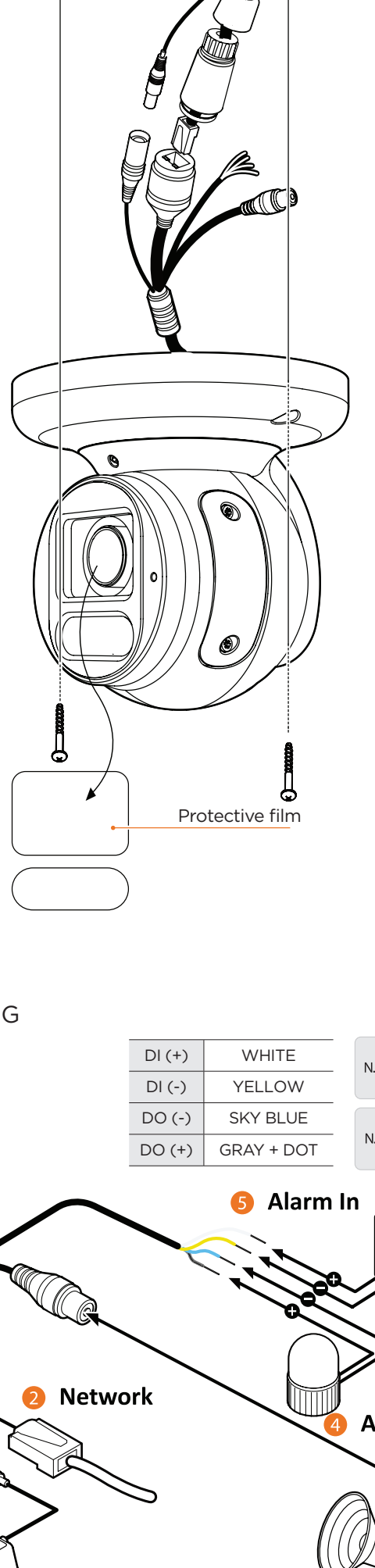
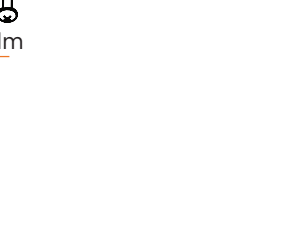

STEP 4 - CABLING

| | | |
|--------|------------|--|
| DI (+) | WHITE | |
| DI (-) | YELLOW | |
| DO (-) | SKY BLUE | |
| DO (+) | GRAY + DOT | |

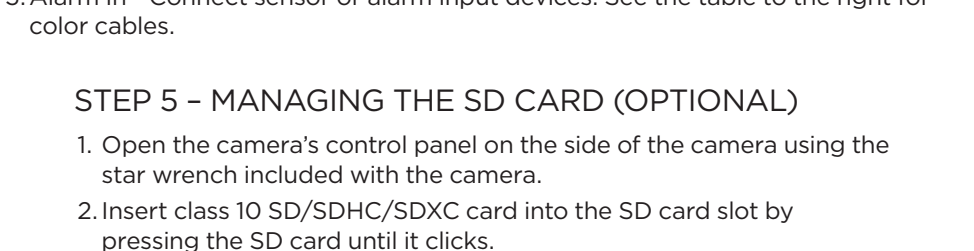

- Power - Connect the camera to a power supply (see STEP 2).
- Network - Connect the camera to a network via a PoE switch (see STEP 2).
- Audio out - Connect external audio devices such as a speaker to the camera.
- Alarm out - Connect alarm devices such as lights, sirens or door locks. See the table to the right for color cables.
- Alarm In - Connect sensors or alarm input devices. See the table to the right for color cables.

STEP 5 - MANAGING THE SD CARD (OPTIONAL)

- Open the camera's control panel on the side of the camera using the star wrench included with the camera.
- Insert class 10 SD/SDHC/SDXC card into the SD card slot by pressing the SD card until it clicks.
- Press the card inward until it clicks to release from the card slot, then remove the card.

NOTE: Maximum SD Card size supported: Up to 1TB micro SD / FAT32. When inserting the SD card into the card slot, the SD card's contacts should be facing upward, as shown in the diagram.

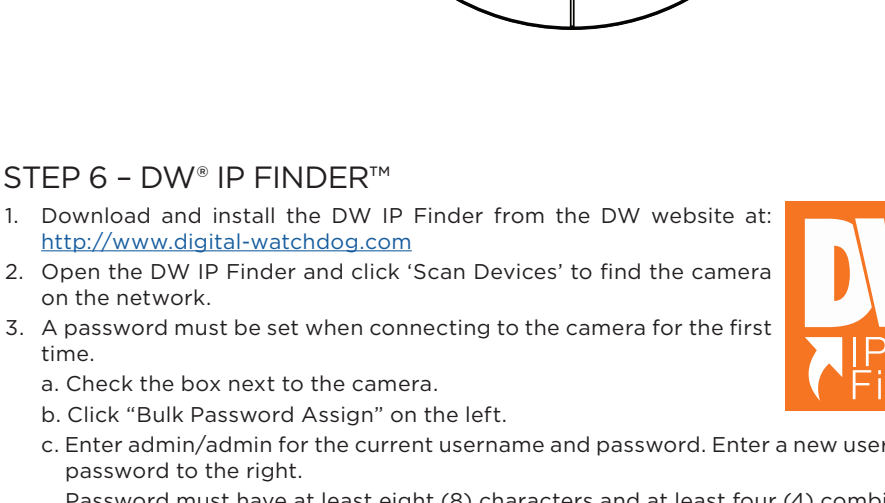

STEP 6 - DW® IP FINDER™

- Download and install the DW IP Finder from the DW website at: <http://www.digital-watchdog.com>
- Open the DW IP Finder and click 'Scan Devices' to find the camera on the network.
- A password must be set when connecting to the camera for the first time.
 - Check the box next to the camera.
 - Click "Bulk Password Assign" on the left.
 - Enter admin/admin for the current username and password. Enter a new username and password to the right.
Password must have at least eight (8) characters and at least four (4) combinations of uppercase letters, lowercase letters, numbers and special characters. Passwords cannot contain the user ID.
 - Click "change" to apply all changes.

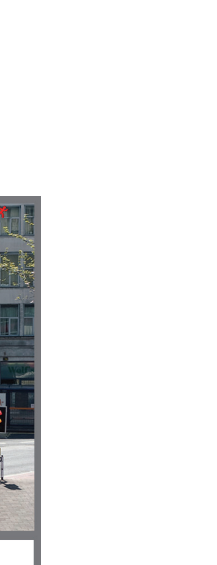

STEP 7 - WEB VIEWER

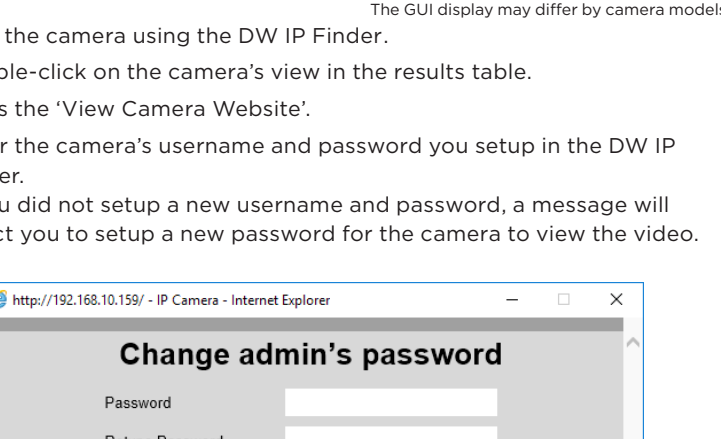

- Find the camera using the DW IP Finder.
- Double-click on the camera's view in the results table.
- Press the 'View Camera Website'.
- Enter the camera's username and password you setup in the DW IP Finder.

If you did not setup a new username and password, a message will direct you to setup a new password for the camera to view the video.

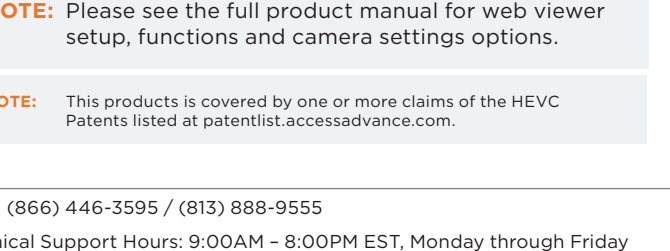

NOTE: Please see the full product manual for web viewer setup, functions and camera settings options.

NOTE: This products is covered by one or more claims of the HEVC Patents listed at patentlist.accessadvance.com.

