

# MEGApix® PTZ™ 3MP and 4K IP Cameras

DWC-XPZA03Mi - 3MP high-speed IP PTZ camera, 60fps

DWC-XPZA08Mi - 4K high-speed IP PTZ camera, 30fps



## *User's Manual* Ver. 11/23

Before installing and using the camera, please read this manual carefully.  
Be sure to keep it handy for future reference.

### Safety Notes

- This product is intended to be supplied by a Listed Power Unit, marked with 'Limited Power Source,' 'LPS' on the unit, output rated minimum POE 48V/ 350mA, no more than 2000m altitude of operation and 60 degrees C.
- As for the modes with PoE function, the function of the ITE being investigated to IEC 60950-1 standard is considered not likely to require connection to an Ethernet network with outside plant routing, including the campus environment, and the ITE is to be connected only to PoE networks without routing to the outside plant.
- Do not try to disassemble the camera; do not remove screws or covers to prevent electric shock.
- There are no user-serviceable parts inside. Please contact the nearest service center as soon as possible if there is any failure.
- Avoid incorrect operation, shock vibration, and heavy pressing, which can cause damage to the product.
- Do not use a corrosive detergent to clean the camera's main body. If necessary, please use a soft, dry cloth to wipe dirt; for hard contamination, use neutral detergent. Any cleanser for high-grade furniture is applicable.
- Avoid aiming the camera directly towards extremely bright objects, such as the sun, as this may damage the image sensor.
- Please follow the instructions to install the camera. Do not reverse the camera, or the reversing image will be received.
- Do not work the camera if temperature, humidity and power supply exceed the limited stipulations.
- Avoid heat sources such as radiators, heat registers, stoves, etc.
- Do not expose the product to the direct airflow from an air conditioner.
- This manual is for using and managing the product. We may reserve the right to amend the typographical errors, inconsistencies with the latest version, software upgrades and product improvements, interpretation and modification. These changes will be published in the latest version without special notification.
- This manual's pictures, charts, and images are only for describing and explaining our products. In this manual, the trademarks, product names, service names, company names, and products our company does not own are the properties of their respective owners.

### Disclaimer

- Concerning the product with internet access, the use of the product shall be wholly at your own risk. Our company shall be responsible for abnormal operations, privacy leakage, or other damages resulting from cyber-attacks, hacker attacks, virus inspection, or other internet security risks; however, our company will supply timely technical support if necessary.
- Surveillance laws vary from country to country. Check all laws in your local Region before using this product for surveillance purposes. We shall not take the responsibility for any consequences resulting from illegal operations.

### Cybersecurity Recommendations

- Use a strong password. At least eight (8) characters or a combination of characters, numbers and upper- and lower-case letters should be used in your password.
- Change the passwords periodically to ensure only authorized users can access the system (the recommended time is 90 days).
- Changing the service default ports (like HTTP-80, HTTPS-443, etc.) is recommended to reduce the risk of outsiders being able to access.
- It is recommended to set up a security system for your router. Important ports such as HTTP, HTTPS and dual ports cannot be closed.

- It is not recommended to expose the device to the public network. When it is necessary to be exposed to the public network, please set the external hardware security system and the corresponding security system policy.
- It is not recommended to use the v1 and v2 functions of SNMP.
- To enhance the security of WEB client access, please create a TLS certificate to enable HTTPS.
- Use black- and white- lists to filter the IP address. This will prevent everyone, except those specified IP addresses, from accessing the system.
- If you add multiple users, limit the functions of guest accounts.
- If you enable UPnP, it will automatically try to forward ports in your router or modem. It is very convenient for users, but this will increase the risk of data leakage when the system automatically forwards ports. Disabling UPnP is recommended when the function is not used in real applications.
- Check the log. If you want to know whether your device has been accessed by unauthorized users or not, you can check the log. The system log will show you which IP addresses were used to log in to your system and what was accessed.

## Regulatory Information

### FCC Information

#### 1. FCC compliance

The products have been tested and found in compliance with the council FCC rules and regulations part 15 subpart B. These limits are designed to provide reasonable protection against harmful interference. This equipment generates uses and can radiate radio frequency energy and, if not installed and used following the instruction manual, may cause harmful interference to radio communication. However, there is no guarantee that interference will not occur in a particular installation. If harmful interference occurs, the user must correct the interface at his own expense.

#### 2. FCC conditions:

The operation of this product is subject to the following two conditions: (1) this device may not cause a harmful interface, and (2) this device must accept any interference received, including interference that may cause undesired operation.

### CE Information

 The products have been manufactured to comply with the following directives.

#### EMC Directive 2014/30/EU



2012/19/EU (WEEE directive): The Directive on waste electrical and electronic equipment (WEEE Directive). To improve the environmental management of WEEE, improving the collection, treatment and recycling of electronics at the end of their life is essential. Therefore, the product marked with this symbol must be disposed of responsibly.

Directive 94/62/EC: The Directive aims to manage packaging and packaging waste and environmental protection. The packaging and packaging waste of the product in this manual must be disposed of at designated collection points for proper recycling and environmental protection.

REACH(EC1907/2006): REACH concerns the Registration, Evaluation, Authorization and Restriction of Chemicals, which aims to ensure a high level of protection of human health and the environment through better and earlier identification of the intrinsic properties of chemical substances. The product in this manual refers to conforms to the rules and regulations of REACH. For more information on REACH, please refer to DG GROWTH or ECHA websites.

# Table of Contents

<b>1</b>	<b>INTRODUCTION .....</b>	<b>1</b>
1.1	PRODUCT AND ACCESSORIES .....	1
<b>2</b>	<b>INSTALLATION .....</b>	<b>2</b>
2.1	POWERING THE CAMERA .....	2
2.2	INSTALLATION.....	2
2.3	CABLING.....	3
2.4	RESETTING THE CAMERA.....	4
<b>3</b>	<b>IP FINDER .....</b>	<b>5</b>
<b>4</b>	<b>SYSTEM OPERATION .....</b>	<b>6</b>
4.1	ACCESSING THE CAMERA'S WEB INTERFACE.....	6
4.2	GUI OVERVIEW.....	7
<b>5</b>	<b>REMOTE CONFIGURATION.....</b>	<b>9</b>
5.1	USING WEB BROWSER .....	9
5.2	VIDEO & AUDIO .....	9
5.2.1	<i>Information</i> .....	9
5.2.2	<i>Video</i> .....	10
5.2.3	<i>Audio</i> .....	12
5.2.4	<i>Output</i> .....	12
5.3	IMAGE.....	14
5.3.1	<i>General</i> .....	14
5.3.2	<i>Schedule</i> .....	19
5.3.3	<i>Mask</i> .....	20
5.3.4	<i>IR Control</i> .....	20
5.4	NETWORK .....	21
5.4.1	<i>IP &amp; Port</i> .....	21
5.4.2	<i>Multicast</i> .....	22
5.4.3	<i>QoS</i> .....	23
5.4.4	<i>Discovery</i> .....	24
5.4.5	<i>One-way</i> .....	24
5.4.6	<i>SNMP</i> .....	26
5.4.7	<i>DDNS</i> .....	27
5.4.8	<i>IP filtering</i> .....	28
5.4.9	<i>Email</i> .....	28
5.4.10	<i>FTP</i> .....	31
5.4.11	<i>Connecting</i> .....	33



5.5	EVENT.....	34
5.5.1	Notification.....	34
5.5.2	User Defined Event .....	36
5.5.3	Motion Detection.....	37
5.5.4	Audio Detection .....	38
5.5.5	Shock Detection .....	38
5.5.6	Sensor .....	39
5.5.7	Alarm.....	40
5.5.8	Event OSD.....	41
5.5.9	HTTP Action.....	41
5.6	DEVICE.....	42
5.6.1	Information .....	42
5.6.2	Serial.....	42
5.7	AI.....	43
5.7.1	AI General.....	43
5.7.2	Object Detection .....	44
5.7.3	AI Analysis .....	47
5.7.4	AI Event .....	50
5.8	PTZ.....	51
5.8.1	General.....	51
5.8.2	Preset.....	52
5.8.3	Pattern.....	53
5.8.4	Swing.....	54
5.8.5	Group.....	55
5.8.6	Advanced.....	57
5.8.7	Direct OSD (ONLY PT System).....	59
5.8.8	Location OSD.....	60
5.8.9	Tracking.....	61
5.9	USER.....	62
5.9.1	User List .....	62
5.9.2	Login Policy.....	65
5.10	SYSTEM.....	66
5.10.1	Information .....	66
5.10.2	Upgrade and Reboot .....	67
5.10.3	Time.....	68
5.10.4	OSD.....	69
5.10.5	Language.....	70

5.10.6 Log.....	71
<b>SPECIFICATIONS.....</b>	<b>72</b>
<b>WARRANTY INFORMATION.....</b>	<b>75</b>
<b>LIMITS AND EXCLUSIONS.....</b>	<b>76</b>

# 1 Introduction

## 1.1 Product and Accessories

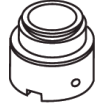
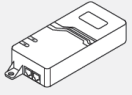
Make sure that you have the following items supplied with your camera. If any items are missing or damaged, notify your vendor immediately. Keep the packing utilities for moving or storage purposes afterward.

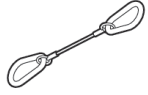
WHAT'S IN THE BOX					
Quick setup and download guides		1	Bracket Adapter		1
PoE injector		1	Adapter Screws (M6 x 12)		3
Safety Wire (for Wall Mount Installation)		1			

NOTE: the camera requires a mounting accessory for complete installation, sold separately. Below are compatible mounting accessories for these cameras:

- DWC-PZPARAMW2 - parapet mount bracket.
- DWC-XPZAWM - wall mount bracket.
- DWC-XPZACNM - corner mount.
- DWC-XPZAPLM - pole mount.
- DWC-XPZACM - ceiling mount bracket.

## 2 Installation

### 2.1 Powering the Camera

Pass the wires through and make all necessary connections. Using a single Ethernet cable, use the PoE Injector included with the camera to connect data and power to the camera.

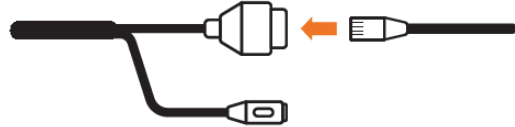

Power requirements	Power consumption
PoE IEEE 802.3bt PoE++ Class7 (PoE injector included)	75W, 1.363A

### 2.2 Installation

1. Install the mounting accessory (sold separately) to the mounting surface according to the installation guide. A mounting accessory is required to install the camera properly. All mounting accessories are sold separately.
2. Pass wires through the mounting bracket.
3. Connect the camera's base to the mounting accessory's neck using the bracket adapter. Secure the camera to the adapter using the adapter screws included with the camera. Secure the camera to the mounting bracket using the screws on the side of the mounting accessory neck.
4. If you are using the wall mount bracket accessory, use the safety wire included with the camera to secure the camera to the bracket's neck.
5. Connect all wires to the camera.
6. Remove the protection film and moisture silica gel when the installation is complete.



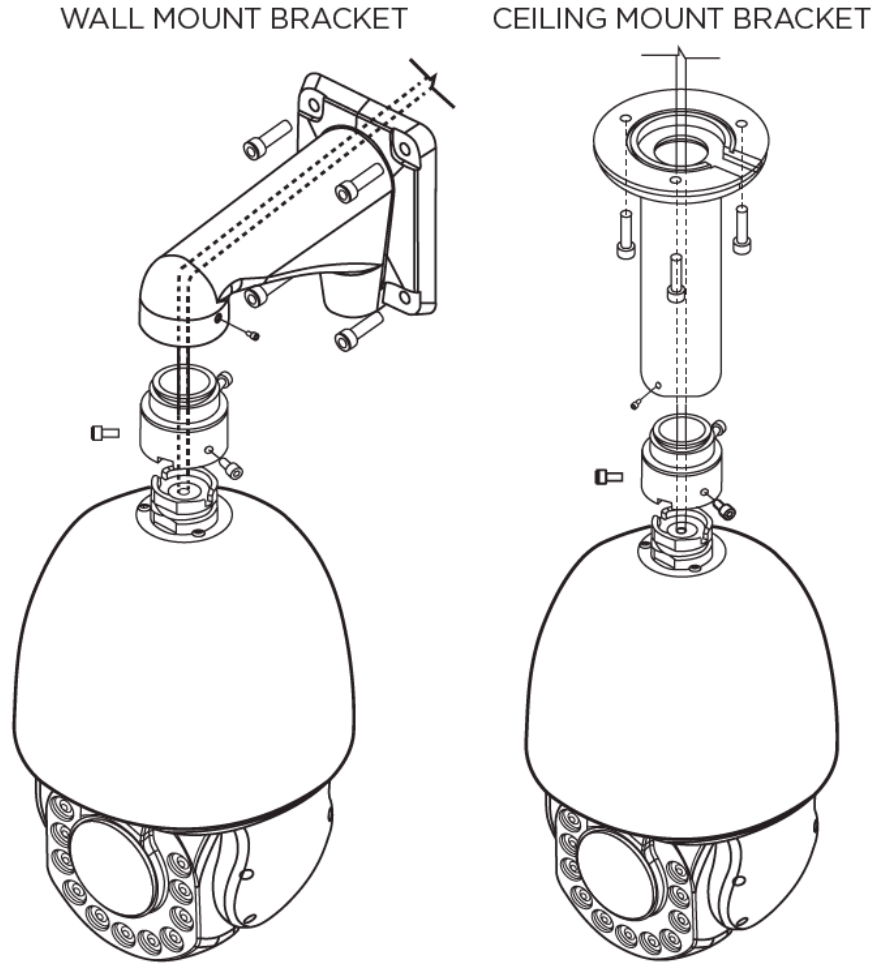

### 2.3 Cabling

Connect the power, network, audio and other supported external devices to the camera.

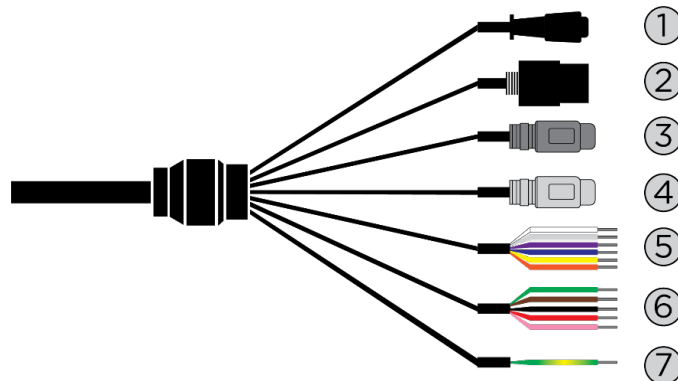

Number	Connector	Wire Color	Description
1	Reset Switch	Black	Reset button (reset IP address and username/password)
2	RJ-45	Black	Ethernet Port

3	RCA Jack	Red	Audio Input
4	RCA Jack	White	Audio Output
5	6-pin Cable	White	Alarm Output1
		Gray	Alarm Com1
		Purple	Alarm Output2
		Blue	Alarm Com2
		Yellow	RS485 -
		Orange	RS485 +
6	5-pin Cable	Green	Alarm Input1
		Brown	Alarm Input2
		Black	Alam Input3
		Red	Alarm Input4
		Pink	GND
7	1-pin Cable	Green/Yellow	GND

## 2.4 Resetting the Camera

Press the reset button with the camera's cables for five (5) seconds to reset the camera's IP address, username and password. For a camera-wide reset, including network settings, go to the camera's web interface under system settings.

## 3 IP Finder

Use the DW® IP Finder™ software to scan the network and detect all MEGApix® cameras, set the camera's network settings or access the camera's web client.

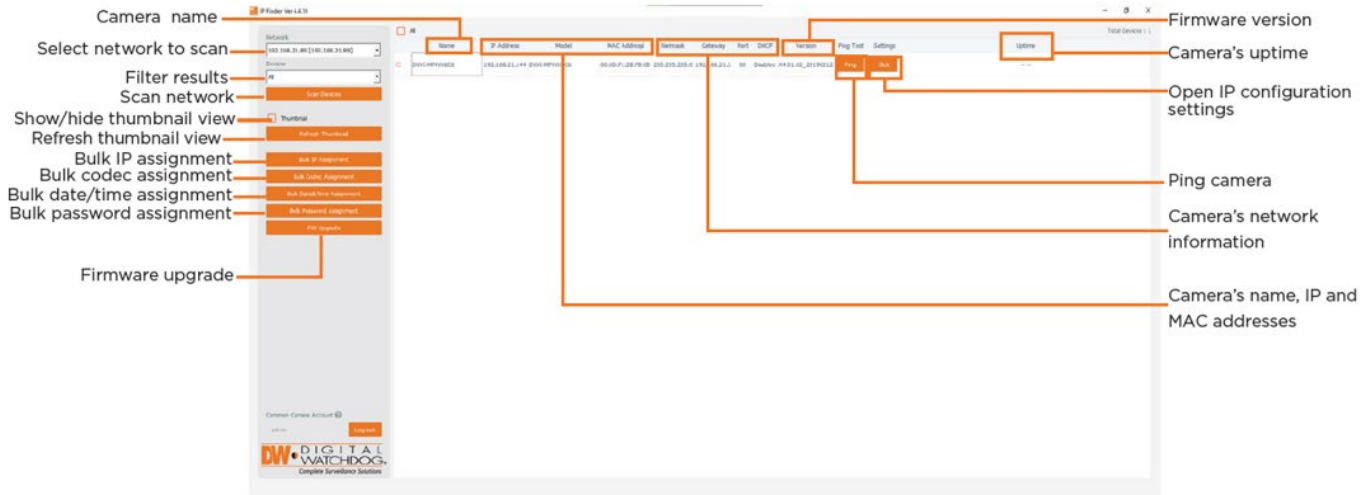

1. To install the DW IP Finder, go to: <http://www.digital-watchdog.com>
2. Enter "DW IP Finder" on the search box at the top of the page.
3. Go to the "Software" tab on the DW IP Finder page to download and install the installation file.
4. Open the DW IP Finder and click 'Scan Devices.' It will scan the selected network for all supported devices and list the results in the table. During the scan, the DW® logo will turn gray.
5. Select a camera from the list by double-clicking on the camera's name or clicking on the 'Click' Button. The pop-up window will show the camera's current network settings. Admin users can adjust the settings as needed. The camera's network settings are set to DHCP by default.
6. Click the 'Website' button to access the camera's web page.
7. To save changes made to the camera's settings, enter the username and password of the camera's admin account and click 'Apply.'

NOTE: Bulk password assignment is currently not supported by the cameras.

# 4 System Operation

## 4.1 Accessing the Camera's Web Interface

1. Find the camera using the DW IP Finder.
2. Double-click on the camera's view in the results table.
3. Press the 'View Camera Website.'
4. When accessing the camera for the first time, a message will direct you to set up a new admin password to view the video.

Default ID: admin

Default Password: admin

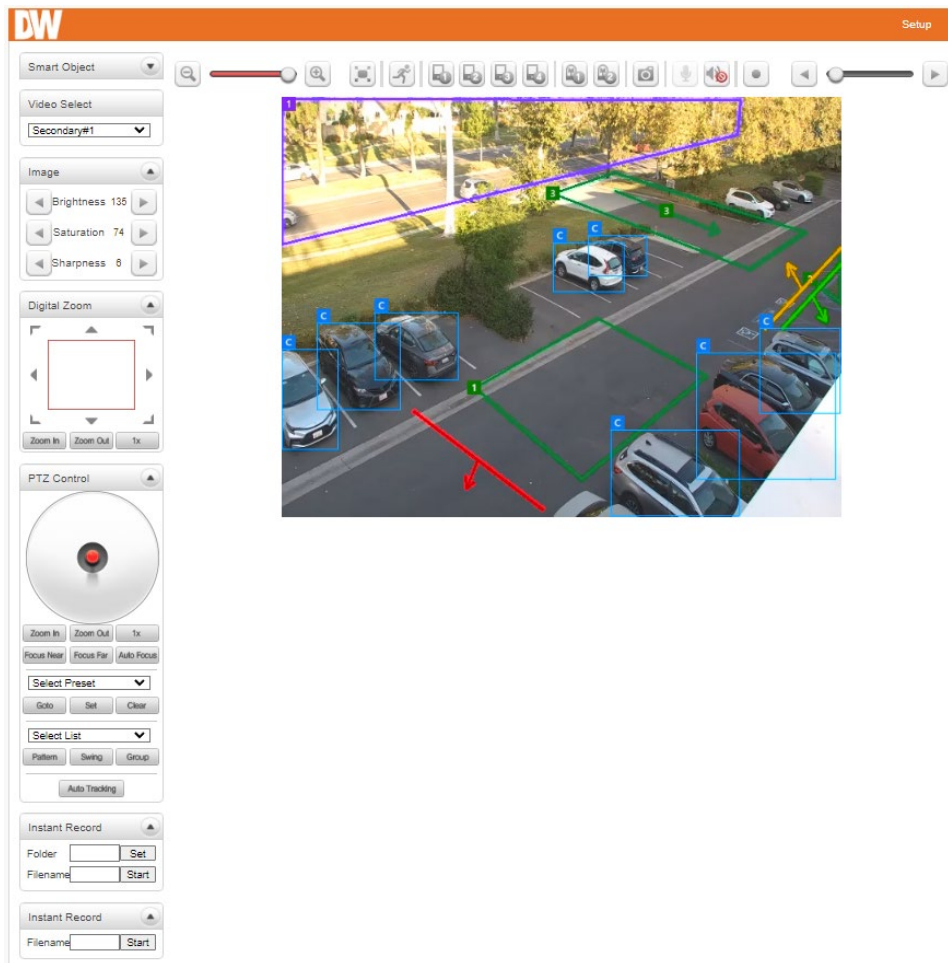

## 4.2 GUI Overview

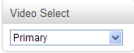
- 
**Video Select:** Select the Video stream to be viewed. The camera is capable of dual streaming, primary streaming and secondary streaming. Video will be displayed according to the resolution set on the video configuration settings. The secondary video is unavailable if dual streaming ("Use Dual Encode" Menu on the Video page) is unavailable.

- 
**View Size:** Adjust the size of the camera's view. This does not impact the camera's optical or digital zoom.

- Digital Zoom:** Control the camera's digital zoom. The more the camera zooms in, the smaller the square of the control panel is. The position of the zoom frame can be changed by moving the square's position. Pressing the x1 button will return the screen to its full size.

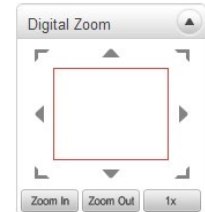



- PTZ Control:** Use the joystick to control the camera's position and view. The further you move the joystick from the center, the faster the camera will move.

- Zoom In, Zoom Out: Control the camera's optical zoom to change the camera's view.
  - Stop: Stop ongoing action.
  - Focus Near, Focus Far, Auto Focus: Adjust the lens's focus. Selecting Auto Focus will adjust the camera's focus automatically to the camera's current Field of View (FOV).



- 
**Select Preset:** Use the drop-down menu to select a preset position for the camera.
  - Go to: Move to the selected preset entry if the preset entry is set.
  - Set: Set the current position to the selected preset entry.
  - Clear: Delete the selected preset entry.

- 
**Sensor Input and Alarm Output:** Display the Sensor status in real-time. This camera supports one sensor input. When the Sensor is activated, the sensor icon will turn red. Operate the alarm device by pressing the number icon. This camera supports one alarm output. A number icon indicates the status of the alarm device.

-  **Snapshot:** Capture images of the camera's current view and save them locally on your computer as BMP or JPEG files.

-  **Talk:** Transfer Audio from the computer's microphone to the camera.

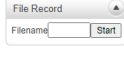
-  **File Record:** Record an AVI file of the camera's live view. The generated file is saved in the download folder.

1. Enter the desired name for the file.
2. Press the "Start" button to start recording.
3. Press the "Stop" button to stop recording.
4. An AVI file named "IP address\_hh\_mm\_ss" or "File name\_IP address\_hh\_mm\_ss" will be generated.

-  **Display Buffer:** Set the number of video frames to be buffered before being displayed on the web browser—a larger value results in smoother video by sacrificing latency. A setting of 10 ~ 15 frames can be used for most situations.

# 5 Remote Configuration

## 5.1 Using Web Browser

Press the **Setup** button in the upper right banner to go to the setup. The camera setup is available for users at a higher level than a manager. The configurations are categorized: **Video and Audio, Image, Network, Event, Device, AI, PTZ, User, and System**. Each category is expandable by pressing the '+' button to the right of the section's name to find additional settings and options.

## 5.2 Video & Audio

### 5.2.1 Information

The information tab provides current information regarding the settings for video and Audio. The information is not editable from this screen. To adjust any of the settings shown, go to the Video or Audio subcategories.

The screenshot shows the DW camera web interface. The top banner is orange with the 'DW' logo on the left and 'Live' on the right. A sidebar menu on the left lists various configuration categories: Video&Audio (expanded), Information (selected), Video, Audio, Output, Image, Network, Event, Device, AI, PTZ, User, and System. The main content area is divided into two sections: 'Video' and 'Audio'.

**Video Settings Table:**

	Enable	Algorithm	Resolution	Bitrate	Framerate
Primary Encoding	On	H.264	3840x2160	9998 (kbps)	30 (fps)
Secondary#1 Encoding	On	H.264	640x480	664 (kbps)	14 (fps)
Secondary#2 Encoding	Off	N/A	N/A	0 (kbps)	0 (fps)
Secondary#3 Encoding	Off	N/A	N/A	0 (kbps)	0 (fps)

**Audio Settings Table:**

	Enable	Algorithm	Sampling rate	Bitrate
Audio Encoding	On	G.711	8 KHz	66 (kbps)
Audio Decoding	On	-	-	0 (kbps)

## 5.2.2 Video

The screenshot displays the DW camera web interface. On the left is a navigation menu with categories: Video & Audio (expanded), Image, Network, Event, Device, AI, PTZ, User, and System. The main area is titled 'View' and shows a live video feed of a parking lot with several cars. Below the video feed is a 'Performance Calculation' section showing a 'Performance Usage Rate' of 84%. Underneath is the 'Video' configuration section, which includes dropdowns for 'Input Format' (3840x2160p30) and 'Smart Stream' (Secondary#1). A tabbed interface allows selection of 'Primary', 'Secondary#1', 'Secondary#2', or 'Secondary#3'. The 'Primary' tab is active, showing settings for Algorithm (H.264 selected), Resolution (3840x2160), Framerate (30), Preference (CBR), Quality (Economy), Bitrate (10000 kbps), I-Frame Interval (30), H.264 Profile (High Profile), and ROI Enable (Off). An 'Apply' button is located at the bottom right of the settings panel.

### Performance Calculation

The calculator shows the performance usage rate according to the value set at 'Encode' mode underneath.

### Video

Video > Input Format:

- Video > Smart Stream:
- Stream Selection: Select ON to enable Secondary #1 - #2. The secondary streams can be viewed on the Live View window by selecting Stream number on Video selection.
- Algorithm: Set the stream to H.264 (default) or H.265. MJPEG is available on secondary streams only.



- Resolution: Select a video encoding solution. The scaling option is used when the encoding resolution differs from the input resolution. Without the Scaling option, the input video will be cut according to the encoding resolution. If Scaling is selected, the input video will be adjusted according to the encoding resolution.
- Framerate: Determine the maximum number of frames per second for the video stream. 1,2,3,4,5,6,8,10,15,20,25,30 and 60 frame rate can be selected. The actual frame rate of video can be less than the maximum frame rate set due to the network bandwidth limitation.
- Preference: Select encoding mode to control video quality or bitrate: Quality(VBR) or Bit rate(CBR and Hybrid). If 'Bitrate' is selected, the video encoding will be affected by the 'Bitrate' value entered. Therefore, "Bitrate" mode corresponds to CBR (Constant Bit Rate) or Hybrid (Hybrid Constant Bit Rate) encoding. If 'Quality' is selected, the video encoding will be affected by the quality of the image selected. Therefore, the "Quality" mode corresponds to VBR (Variable Bit Rate) encoding.
- Quality: Select Video quality from the seven (7) levels available. Quality mode (VBR encoding) tries to encode every frame in a constant quality. The resulting bitrate may vary depending on the complexity or activity changes in the input video. It is preferred when constant video quality is required and network bandwidth is enough to deliver a highly varying bitrate stream.
- Bitrate: Determine bitrate value between 32 - 16Mbps. Bitrate mode (CBR encoding) allows you to set a fixed target bitrate that consumes a predictable bandwidth. In this case, video quality is controlled dynamically to keep the bitrate fixed.
- I-Frame Interval: Determine I-frame Interval between 1 and 255.
- ROI Encoding: Select ON to enable the use of ROI. Users can make an area for ROI on the Secondary stream.

### 5.2.3 Audio

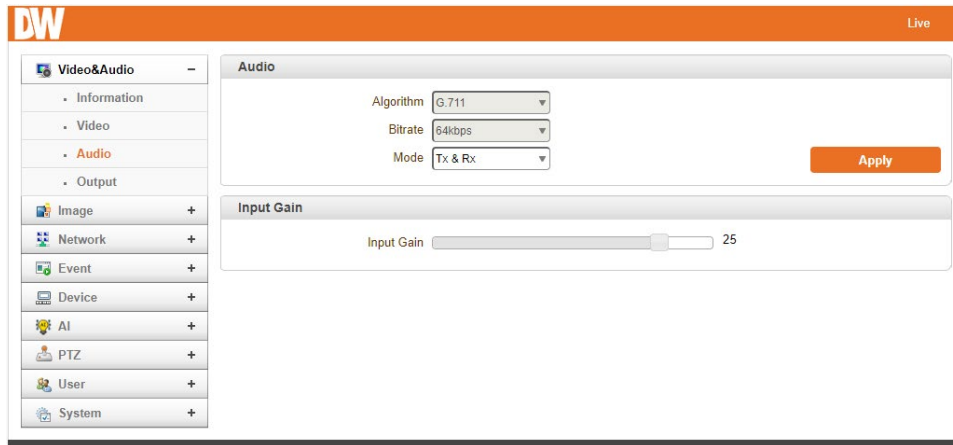

#### Audio

- Algorithm: Select the audio algorithm: G.711 or AAC. G.711 and AAC from client to server direction are supported. Thus, bidirectional audio communication is supported.
- Bit rate: Select between 64Kbps and 128Kbps when AAC is selected. The sampling rate is fixed to 8KHz and 32KHz for G.711 and AAC, respectively. Note that when the camera is connected to a decoder, the decoder’s audio algorithm should be set identically to transmit Audio properly.
- Mode: Select audio operation mode.

Mode	Action
Off	No operation
Tx-Only	Transmit only
Rx-Only	Receive only
Tx & Rx	Transmit and receive

#### Input Gain

Set audio input gain from 0 to 31.

### 5.2.4 Output

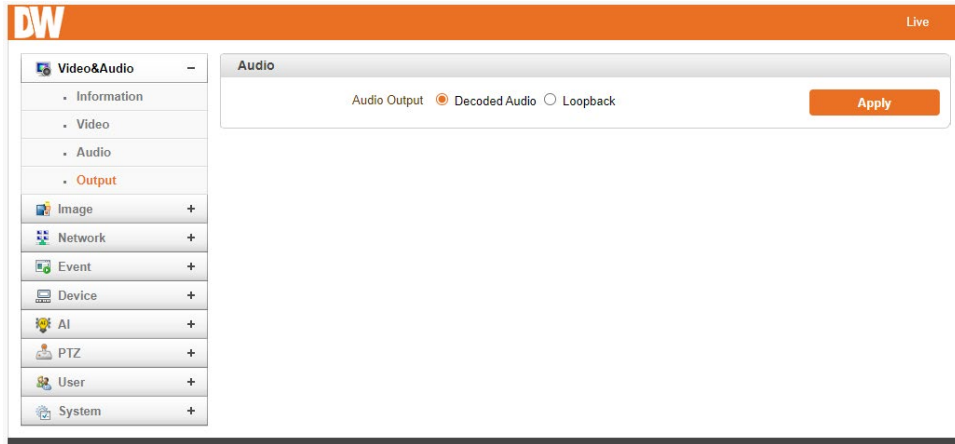

- Output Format: Select the format of output when Enable Preview is selected.
- Audio Output:
  - Decoded Audio: The input audio is transmitted to the encoder.
  - Loopback: Does not transmit the Audio to the encoder.

## 5.3 Image

### 5.3.1 General

Users can adjust the camera's image settings. Users can create multiple configuration settings (up to four) based on the camera's varying needs.

The screenshot displays the DW camera's configuration interface. On the left is a navigation menu with categories: Video&Audio (+), Image (-), Network (+), Event (+), Device (+), AI (+), PTZ (+), User (+), and System (+). The 'Image' category is expanded to show sub-options: General, Schedule, Mask, and IR Control. The main window is titled 'View' and shows a live video feed of a parking lot with several cars. Below the video feed are four tabs labeled 'Config Set #1', 'Config Set #2', 'Config Set #3', and 'Config Set #4'. The 'Exposure' settings are expanded, showing the following controls:

- Exposure Target: Slider set to 20
- Exposure Mode: Dropdown menu set to 'Advanced'
- Slow Shutter Mode: Dropdown menu set to 'Auto'
- Shutter Range: Slider ranging from 1/125 to ~1/100000
- User Shutter: Dropdown menu set to 'Off'
- Analog Max Gain: Slider set to 30
- Speed: Slider set to 4
- IRIS Mode: Dropdown menu set to 'Auto'
- BLC/WDR Mode: Dropdown menu set to 'Off'
- Gamma Index: Dropdown menu set to 'Auto(Fine)'

A 'Default' button is located at the bottom of the configuration panel.

### Exposure

Users can adjust the camera's exposure, Shutter, Gain, Iris, and address harsh lighting.

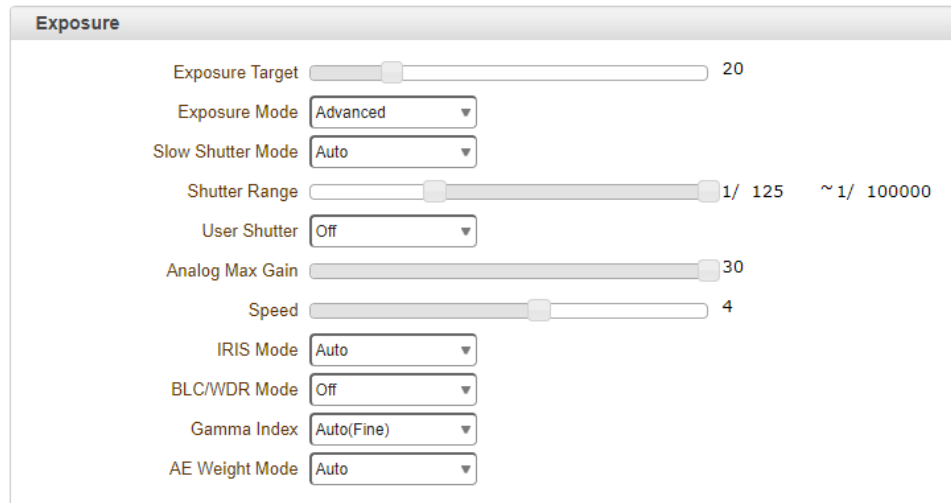

- Exposure Target: Adjust the brightness of the camera's image between 0-100. The higher the value, the brighter the image becomes.
- Exposure Mode:
  - Advanced: Slow Shutter, Shutter speed, Gain and Iris ranges can be set manually.
  - Full Auto: Auto Iris and Gain, Fixed Shutter Speed (59.94/1/60 sec)
- Slow Shutter Mode: In low-light environments, enable the camera's slow shutter feature to use a slower shutter speed to capture more light.
- Shutter Range: If exposure mode is set to "Advance," adjust the Shutter's range bar. The moving object can be photographed without the ghost effect if this speed is faster. However, the picture can be dark if the lighting is insufficient.
- User Shutter: Select a shutter speed from the options in the drop-down menu.
- Analog Max Gain: Adjusts image gain. The lower the value, the darker the image will appear.
- Speed: Adjust the speed of shutter.
- IRIS Mode:
  - Auto: Based on Zoom magnification, operates as IRIS AUTO. IRIS closes when zoom in.
  - Manual: FIX IRIS based on F-Stop number.
- BLC/WDR Mode:
  - Back Light Compensation: The camera can balance the lighting in a scene with an extremely bright background, such as sunlight. It helps to obtain the finest light contrast and get a clear image.
  - WDR: The Wide Dynamic Range mode is a function for dividing an image into several blocks and correcting blocked-up shadows and blown-out highlights following the intensity difference. It

enables you to obtain images in which portions ranging from dark to light can be recognized, even when capturing a subject with a large intensity difference that is backlighted or includes extremely light portions.

- Gamma Index: Gamma correction can be changed in this mode.
- AE Weight Mode:
  - Auto: Allow camera to automatically determine lens exposure settings.
  - Manual: Set fixed exposure settings.

### **Color & Filter**

Users can adjust the camera's lighting, fix digital noise and other image quality settings under this section.

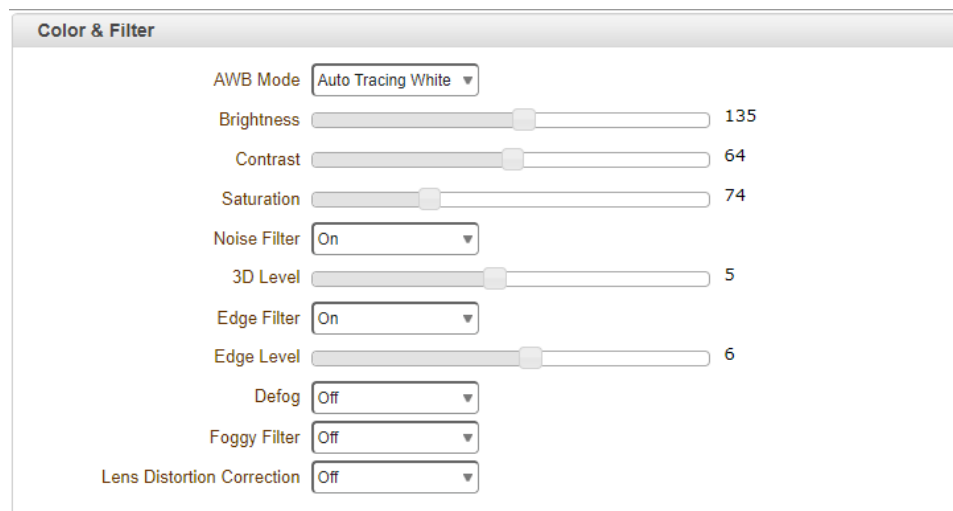

- AWB Mode: White Balance has the following modes.
  - Auto: This mode computes the white balance value output using color information from the entire screen. It outputs the proper value using the color temperature radiating from a black subject based on a range of values from 3000 to 7500K.
  - Manual: Manual control of R and B gain, 256 steps each.
  - ATW (Auto Tracking WB): Auto Tracking White balance (2000K to 10000K)
- Brightness: Controls input video brightness by selecting values between 0 and 255.
- Contrast: Controls input video contrast by selecting values between 0 and 255.
- Saturation: Controls input video saturation by selecting values between 0 and 255.
- Noise Filter: Normal 3D : start to work 3D NR (refer to 1frames on 3D NR)

- 3D Level: The higher the level is, the less noise in the video. However, it can cause image distortion. It should be configured by users, depending on scene requirements.
- Edge Filter: Users are allowed to configure to have sharp and clear edge in the video.
- Edge Level: Default is 5. Lower than default, edge appears less sharp. Higher than 5, edge appears sharper but with low exposure, noise will appear.
- Defog: Images in extraordinary environments such as fog, rain, or a very strong luminous intensity have a lower dynamic range than ordinary images. This camera has a contrast-based defog function, which is used to overcome such shortcomings.
- Foggy Filter: Status of Defog mode. Options include OFF, always ON, or Night only.
- Lens Distortion Correction: If there is any distortion in the camera's field of view, enable this setting to try to correct it.

### **Day & Night**

The camera delivers color images during the day. Light diminishes below a set level, so the camera can automatically switch to night mode (Black and white mode) to maintain good image quality.

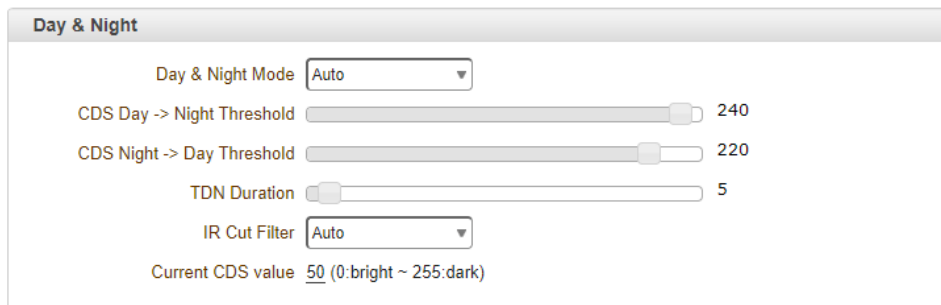

Day & Night

Day & Night Mode

CDS Day -> Night Threshold

CDS Night -> Day Threshold

TDN Duration

IR Cut Filter

Current CDS value

- Day & Night Mode:
  - Auto: Automatically switches to Day (Color) or Night(B&W) according to light using ICR (Infrared Cut Filter Removable)
  - Day (Color): Deliver color image regardless of light.
  - Night (B/W): Deliver B/W image regardless of light
- CDS Day > Night Threshold: Set the CDS value when the light goes below that level for the camera to switch from color day mode to B/W night mode.
- CDS Night > Day Threshold: Set the CDS value when the light goes above that level for the camera to switch from B/W night mode to color day mode.

- TDN Duration: Determines True Day/Night duration timer; determines the amount of time that the camera will wait before switching between Day/Night modes.
- IR Cut Filter: Control the camera's IR cut filter and its impact on the camera's transition between color and B/W image.
- Current CSD Value: This shows the current CSD value for the camera's view. The higher the number, the brighter the image.

## **ETC**

This menu allows users to adjust settings, such as flipping the camera's image or enabling digital zoom.



The screenshot shows a settings window titled "ETC" with a light gray header. Below the header, there are four settings, each with a label and a dropdown menu:

- Horizontal Flip: Off
- Vertical Flip: Off
- Minimum Focus Length: 10m
- Digital Zoom: Off

- Horizontal Flip: When enabled, the camera's view will be flipped from left to right.
- Vertical Flip: when enabled, the camera's view will be flipped up to down.
- Minimum Focus Length: Can be set from 10cm to 10m.
- Digital Zoom: Determine to use Digital zoom (16x) supported by the camera zoom lens.



### 5.3.2 Schedule

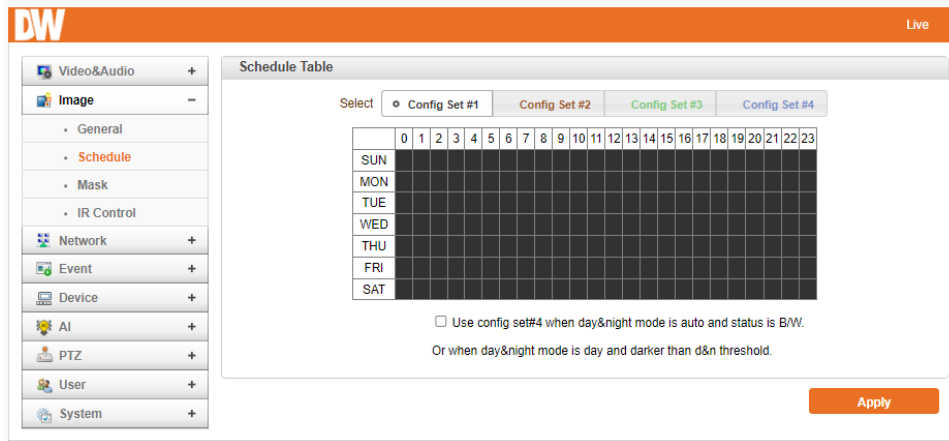

Users can set different schedules for different camera configurations.

- Configuration Set: 4 different configuration sets can be configured by opening the page with Config Set#N. buttons. For example, Config Set#1 can be configured for day and Config Set#2 for night mode.
- Scheduling of the configurations: Cells in the weekly/hourly schedule table can be set to appropriate configurations by clicking a specific cell or a cell for an hour or a cell for a day of a week.

### 5.3.3 Mask

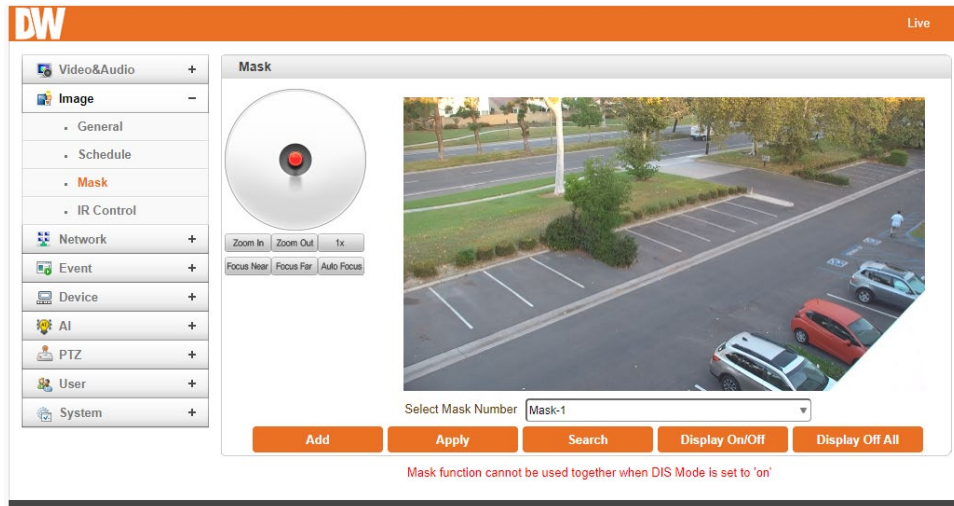

Masks can be displayed in the video.

1. Position the camera and select one of the Masks from the drop-down menu.
2. Press the 'New' button to get a mask and adjust its size with the size buttons.
3. The 'Search' button can show the specified mark.

### 5.3.4 IR Control

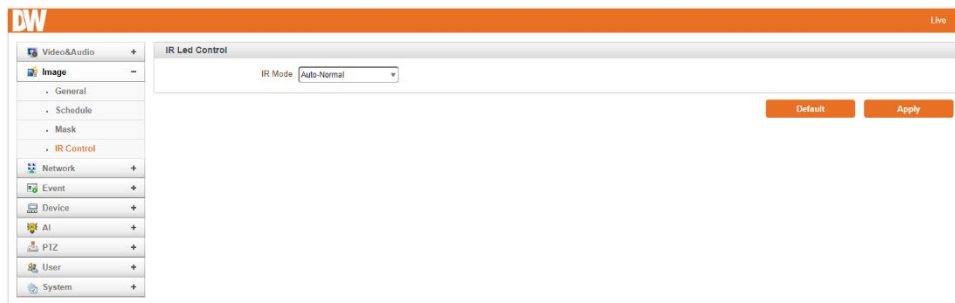

Users can control the Near LED and Far LED manually.

## 5.4 Network

### 5.4.1 IP & Port

The screenshot shows the 'IP & Port' configuration page. On the left is a navigation menu with categories like Video&Audio, Image, Network, Event, Device, AI, PTZ, User, and System. The main content area is divided into several sections:
 

- Local:** IP Mode is set to DHCP.
- DNS:** Option 'Use the following DNS server addresses' is selected. Primary DNS Server is 8.8.8.8 and Secondary DNS Server is 8.8.8.8.
- IPv6:** IPv6 Address, IPv6 Subnet Prefix Length (0), IPv6 Default Gateway, and IPv6 LinkLocal (fe80::21c:63ff:fed4:59d0/64) are shown.
- Port:** Base Port (2222), HTTP Port (80), HTTPS Port (443), RTSP Port (554), and Audio Receive Port (2280) are configured with their respective ranges.
- MTU Size:** MTU Size is set to 1500 (default: 1500, 68-).
- Multicast:** Multicast IP is 224.10.0.0 (range 224.0.0.0 - 239.255.255.255) and TTL is 64 (range 1-255).

 An 'Apply' button is located at the bottom right of the configuration area.

#### Local

- Select the IP mode: Fixed IP or DHCP. Depending on the selected mode, further configuration items come as follows:

IP Mode	Selection	Description
Fixed IP	Local IP	Fixed IP address
	Local Gateway	Gateway IP address
	Local Subnet	Subnet mask
DHCP	N/A	

Contact your network administrator or Internet Service Provider (ISP) for more information.

## DNS

- Obtain DNS server address automatically: Get DNS server address automatically when IP mode is DHCP.
- Use the following DNS server address: Enter the DNS server IP address, Primary or Secondary DNS server.

## IPv6

- Ipv6 Address: Enter the designated Ipv6 address.
- Ipv6 Subnet Prefix Length: Enter the bit number of Ipv6 Subnet
- Ipv6 Default Gateway: Enter the designated Ipv6 gateway.
- Ipv6 Link Local: Display Ipv6 Link Local.

## Port

- Base Port (1025-65535): Enter the Base Port number. The network base port is used for communication with remote clients. The port number must be identically configured on the camera and client sides to connect the camera and remote systems.
- HTTP Port (80, 1025-65535): Enter the HTTP port used for the web-based connection.
- HTTPS Port (443, 1025-65535): Enter the HTTPS port for the secured HTTP connection.
- RTSP Port (554, 1025-65535): Enter RTSP port used for RTSP-based connection. The default TRSP port is 554. RTSP (Real Time Streaming Protocol) is a standard for media streaming between server and client.

### **5.4.2 Multicast**

The Multicast menu configures the multicast IP address to which the media stream is delivered when a client such as a Decoder, VMS or NVR software is connected in multicast mode. The multicast IP address selection range is between 224.0.0.0 and 239.255.255.255. The selection can be used when the media protocol is set to Multicast.

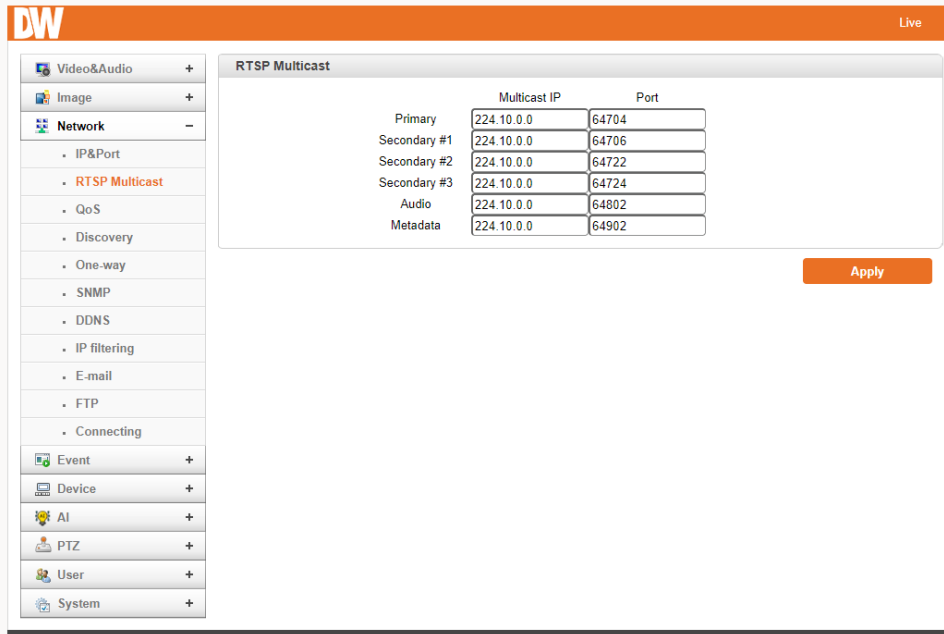

### 5.4.3 QoS

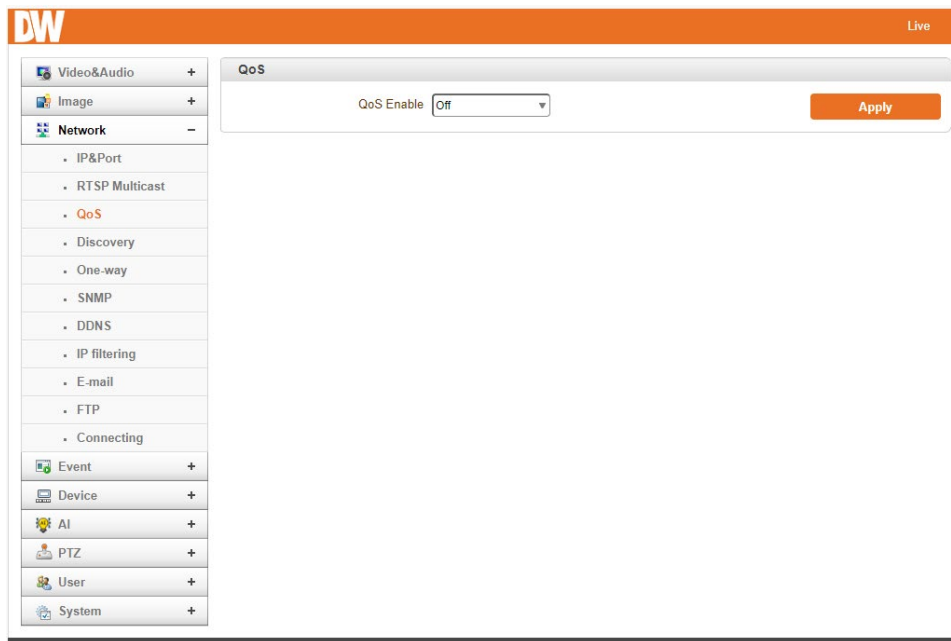

Quality of Service (QoS) by managing the delay, delay variation (jitter), bandwidth, and packet Loss parameters on a network become the secret to a successful end-to-end business solution.

## 5.4.4 Discovery

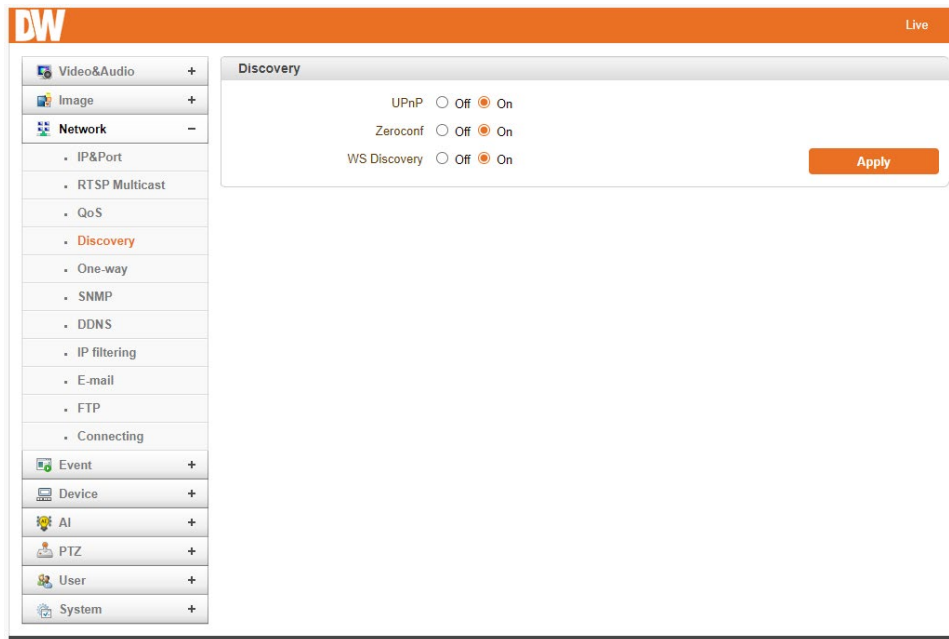

- UPNP: Setting UPNP to ON allows the discovery by the clients according to the UPNP (Universal Plug and Play) protocol.
- Zeroconf: Setting Zeroconf to ON allows the camera to be discovered by clients using the Zeroconf protocol.
- WS Discovery: Discovery function based on web service is enabled. It allows the discovery by the client SW, which is supporting Onvif.

## 5.4.5 One-way

This IP camera provides two kinds of one-way (unidirectional) streaming based on UTP to clients: RTMP and MPEG-TS. Both are a kind of broadcasting where traffic from clients to a server is not generated.

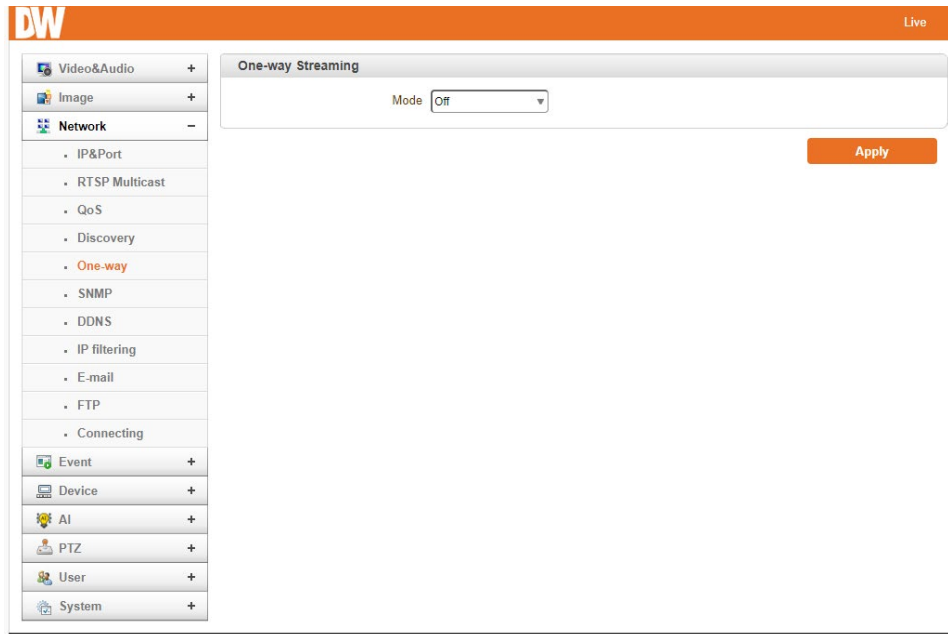

- RTMP is an Internet protocol for transmitting real-time multimedia data, such as Audio and video, to a select group of connected clients. Normally, RTSP uses RTP to format packets of multimedia content. The RTP menu is used when the RTP only streaming without an RTSP connection. RTP stream will be transmitted to the destination set. The SDP (Session Description Protocol) file can be found on the server, and a client can retrieve it using an HTTP connection.
  - Related settings:
    - ◆ Destination IP: Set the IP Address of the destination system that will receive RTP Stream. If the system is a decoder, RTSP authentication information can be in the middle of the RTSP URL as follows: `rtsp://admin:admin@192.168.10.100:554/video1`
    - ◆ Destination Port: Set the port of the destination system that will receive the TRP stream.
    - ◆ User Name: Enter the user name used as the session name in the SDP file.
    - ◆ File Name: Enter the file name that will be used as the name of the SDP file. Then, it can be accessed through `http://ServerAddress/filename`.
- MPEG-TS is a standard format for transmitting and storing Audio, video, and data [7] and is used in broadcast systems such as DVB and ATSC. Transport Stream is specified in MPEG-2 Part 1, Systems (formally known as ISO/IEC standard 13818-1 or ITU-T Rec. H.222.0). Transport stream specifies a container format encapsulating packetized elementary streams, with error correction and stream synchronization features for maintaining transmission integrity when the signal is degraded. As MPEG-TS supports only AAC as the audio algorithm, only video is streamed when the audio algorithm is set to G.711.

- Related settings are as follows:
  - ◆ Destination IP: Set the IP Address of the destination system that will receive the MPEG-TS stream.
  - ◆ Destination Port: Set the Port of the Destination system, which will receive MPEG-TS stream.

## 5.4.6 SNMP

The screenshot displays the SNMP configuration interface. The left sidebar menu includes: Video&Audio (+), Image (+), Network (-), IP&Port, RTSP Multicast, QoS, Discovery, One-way, **SNMP**, DDNS, IP filtering, E-mail, FTP, Connecting, Event (+), Device (+), AI (+), PTZ (+), User (+), and System (+). The main configuration area for SNMP includes:
 

- SNMP Listen Port: 0 (range: 0, 161, 1025-65535)
- SNMP Trap Destination IP: 0.0.0.0
- SNMP Trap Destination Port: 162 (range: 0, 162, 1025-65535)
- SNMP Version: 2c
- Read Community: public
- Write Community: private

 An 'Apply' button is located at the bottom right of the configuration panel.

This menu allows users to configure the SNMP (Simple Network Management Protocol) for the camera. The camera is compatible with SNMPv1 and SNMPv2c.

- SNMP Listen Port (0, 161, 1025 ~ 65535).
- The port connects external devices when the system operates as an SNMP client. SNMP is not used by setting a 0 value.
- SNMP Trap Destination IP.
- Set the SNMP Trap Destination IP.
- SNMP Trap Destination Port (0, 162, 1025 ~ 65535).
- Set the SNMP Trap Destination Port. SNMP is not used by setting a 0 value.



## 5.4.7 DDNS

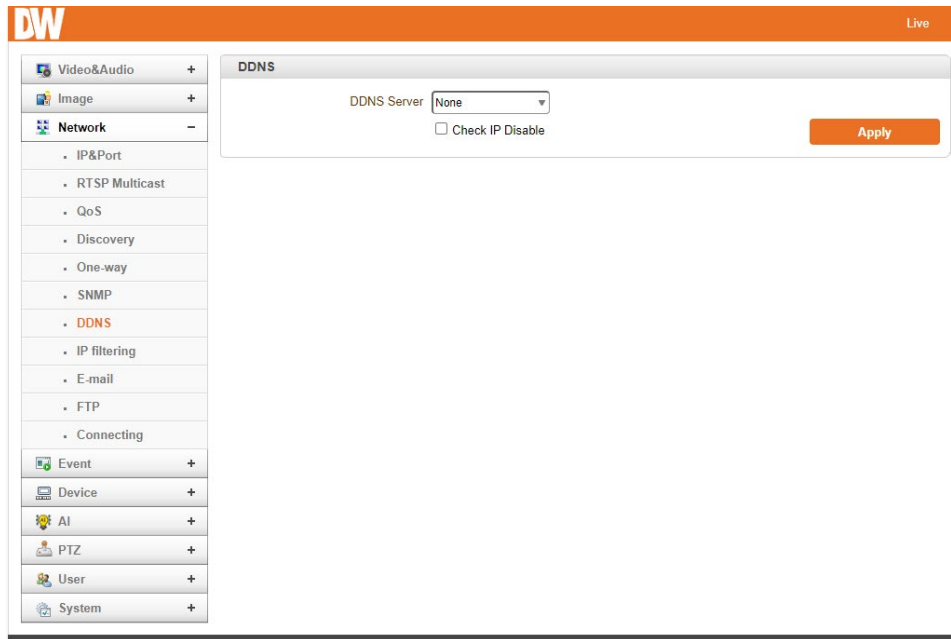

Select the DDNS (Dynamic DNS) server to use. One of the two can be selected.

- DynDNS: Dyn DNS service is used in this mode. Refer to [www.dyndns.org](http://www.dyndns.org) for details. ID, Password and Domain name are needed when DYN DNS is set.
- Check IP Disable: If "Check IP Disable" is selected, it will skip to check its IP. The set IP will be registered on the DDNS server in fixed IP mode. In DHCP mode, dynamically assigned IP will be registered on the DDNS server. Normally, '**Check IP Disable**' should be unchecked to obtain public IP in the network.

### 5.4.8 IP filtering

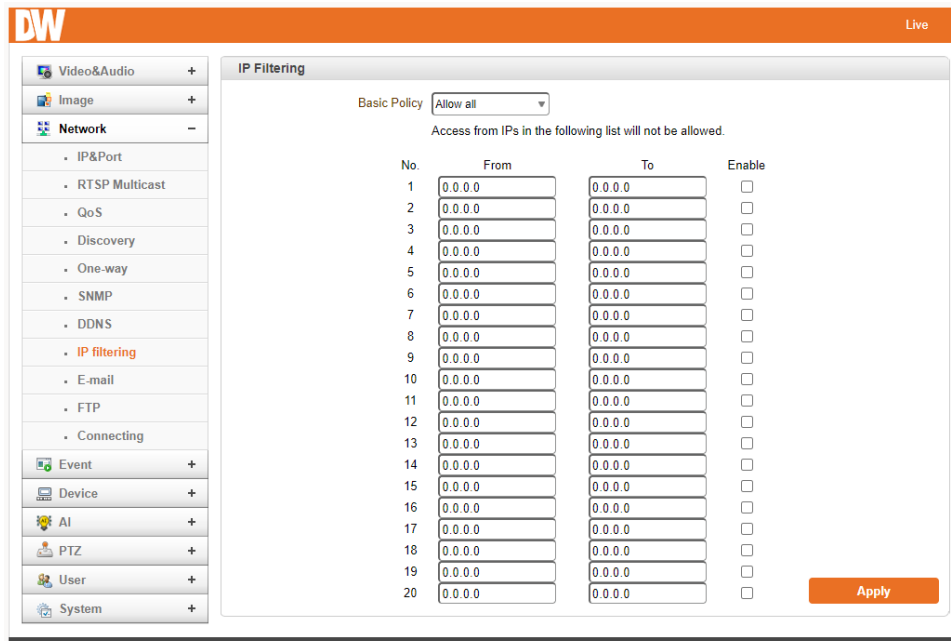

IP filtering is simply a mechanism that decides which types of IP datagrams will be processed normally and which will be discarded.

### 5.4.9 Email

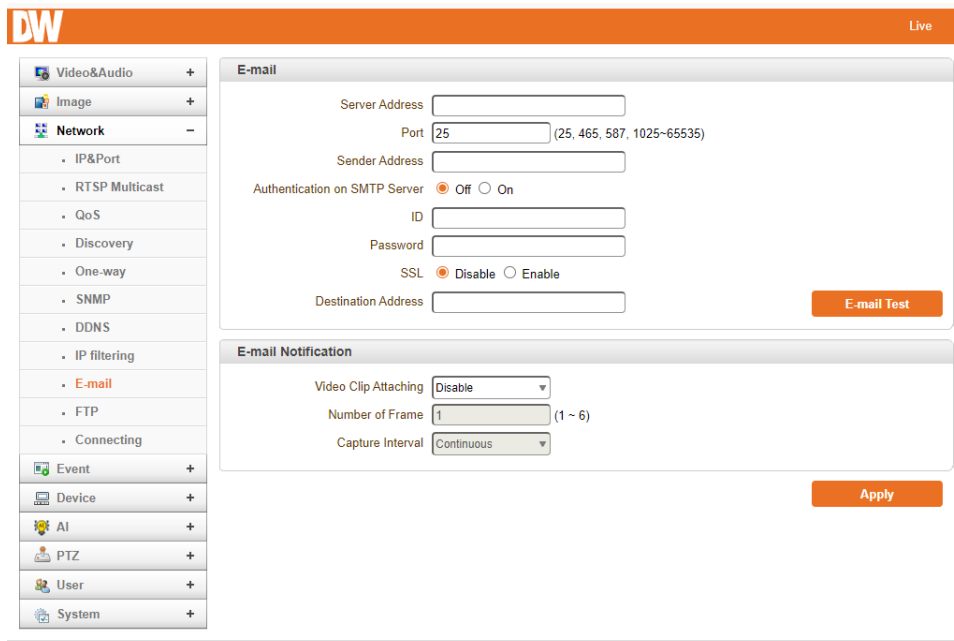

**Email**

When email is selected as an event action, specify the information to send event information.

- **Server Address:** Enter the address of the mail (SMTP) server
- **Port:** Specify a port for SMTP operation. (Port 25 is the default port in SMTP operation. If a different port is configured in the SMTP server, this port needs to be changed accordingly.)
- **Sender Address:** Enter an account registered in the SMTP server.
- **Authentication on SMTP server:** This function is applicable when the Email server requires authentication for sending email.
- **ID and Password:** When the server requires authentication, the ID and Password of an Email account need to be entered.
- **Destination Address:** Enter Destination address. Multiple addresses can be entered by delimiting comma (,) or semi-colon (;). The destination address can take up to 63 characters.
- **Email Test:** email sending can be tested with this button. Please note that configured settings should be saved by pressing the Apply button before using the email Test function. One of the following messages will come as a result of the test.

Message	Description
Email sent successfully	The test email has been sent successfully. Reception in the client can be checked.
Failed to connect to SMTP server	Connection to the SMTP server failed. It is necessary to check if the server is reachable and the server address and port are correct.
Authentication failed	The server is reachable, but authentication failed. ID and/or password need to be checked.
SMTP server rejected the mail	The server is reachable, but mail sending failed for reasons other than authentication. This error often happens when the server authenticates according to its own rules. For example, IP addresses of a specific range or addresses of a specific suffix are allowed.

**Email Notification**

- **Video Clip Attaching:** A video clip stored at the moment of the event can be attached as an AVI or JPEG file format. When dual or quadruple encoding is enabled, Primary video, Secondary video (H.264

only) or JPEG Capture can be selected. The number of JPEG frames is configured. This setting is applicable only when JPEG Capture is selected.

- Capture Interval: Select the interval of the captured frame.

### 5.4.10FTP

Specify the information to upload event information when FTP is selected as an event action.

### FTP

- Server Address: Enter the address of an RTP server to receive video files
- Port: Specify a port for FTP operation. (port 21 is the default port in FTP operation. If a different port is configured in the FTP server, this port needs to be changed accordingly.)
- ID & Password: Enter ID and password for accessing the FTP server.
- FTP file name: The names of files uploaded by FTP can be specified by the user. If a fixed name is specified, the file is overwritten repeatedly. The length of a file name is 60 characters. If the name is left blank, the file name is determined according to the internal rule implemented in the firmware. The following macros are supported to form variable parts of file names. The strings are case-sensitive.
- %YYYY: year  
%MM: month  
%DD: day  
%hh: hour  
%mm: minute  
%ss: second  
%EVENT: event type (Sensor1, Motion, ...)

%ADDR: address of the server (Domain name when DDNS is used. Otherwise IP address)

".avi" or ".jpg" will be added automatically at the end of the filename, depending on the video file type.

- FTP Base Directory: Specify the directory's name to be created in the FTP server. It is valid only when Use Record is set to Use on Record session.
- FTP Test: The FTP upload function can be tested with this button. Please note that configuration settings should be saved by pressing the Apply button before using the FTP test function. One of the following messages will appear as a result of the test.

Message	Description
FTP connection tested successfully	The connection to the FTP server is successful.
Failed to connect FTP server	The connection to the FTP server failed. It is necessary to check if the server is reachable and server address and port are correct.
Authentication failed	The server is reachable but authentication failed. ID and/or password need to be checked.
Failed to upload file	File upload failed. The user of the ID is not allowed for writing into the directory or FTP server can be full.
Failed to erase file	Failed to delete the test file. The user of the ID doesn't have the privilege for file deletion.

### FTP Upload

- Upload Video: Primary and secondary, tertiary or quartic video (H.264 only), JPEG capture can be selected for uploading.
- Number of Frame: Enter the frame number of the JPEG captured. (1 - 10)
- Capture Interval: Select the interval of the captured frame.
- Continuous Upload: Continuous upload 'ON' allows video clips to be transmitted regularly regardless of the event's occurrence. When this mode is activated, FTP upload by event is suppressed.
- Upload Duration: Specify the recording duration of a video clip to be transmitted. (max 300 sec.)
- Upload Interval: Specify transmission interval. (max 3600 sec.). Upload duration is not included in the upload interval. For example, if the upload interval is 60 seconds and the upload duration is 20 seconds, a video clip for 20 seconds is transmitted every 80 seconds.

### 5.4.11 Connecting

The window shows the IP address of all clients currently connected to the camera.

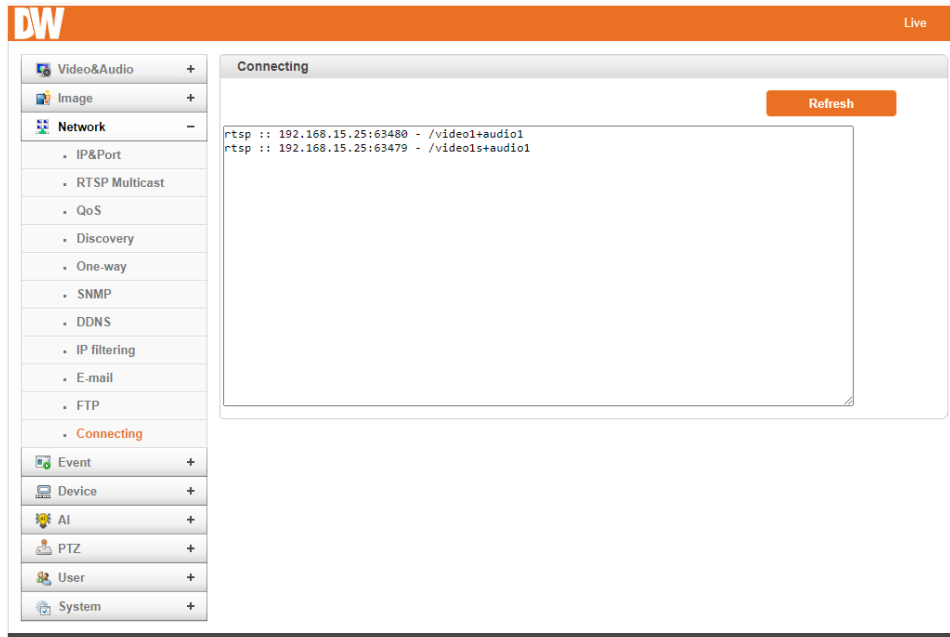

## 5.5 Event

### 5.5.1 Notification

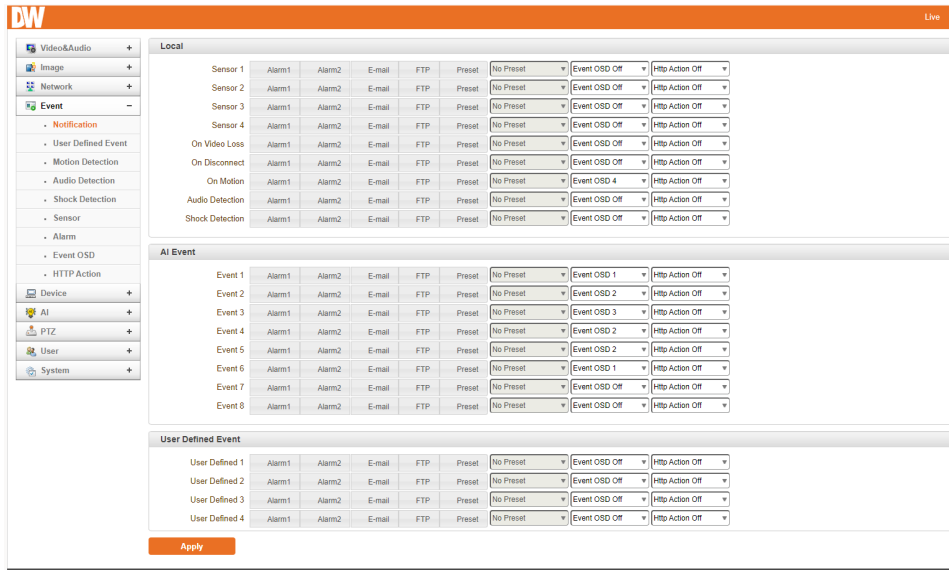

Then, actions for events can be configured for events from the remote system and local system. For example, it is possible to turn on an alarm device in a local (center) decoder system when a sensor device in a remote (site) IP camera is triggered. **The local** section configures the actions for events from the local (self) system. Configuration activates local devices, and the **Remote** sections configure the actions for events from the remote (peer) system. The following table lists the possible actions for events.

Action	Description
Beep	Triggers beep port.
Alarm out	Triggers alarm (relay) port.
Email	Send an email to a specified address. An AVI file can be attached.
FTP	Upload an AVI file to a specified FTP server.
Google Drive	Upload to Google Drive storage.
Preset	Move to the Preset position.
Event OSD	Display OSD.
HTTP API	Transmit HTTP API.



**Local**

- Sensor1-4: Configure the actions when the Sensor is activated. Multiple actions can be set for a single event.
- On Video Loss: Configure the actions when the video input signal is lost. Multiple actions can be set for a single event.
- On Disconnect: Configure the actions when the link (connection) with the peer system is disconnected. Multiple actions can be set for a single event. This event happens when the last client, receiving video from the camera, loses the connection.
- On Motion: Configure the actions when motion is detected. Multiple actions can be set for a single event.
- Audio Detection: Configure the actions when Audio is detected. Multiple actions can be set for a single event.
- Shock Detection: Configure the actions when the camera detects strong shock vibrations. Multiple actions can be set for a single event.

**AI Event**

- Event 1-8: Configure the actions when an event triggered by the AI settings occurs. Multiple actions can be set for a single event.

**User Defined Event**

- If specific user events were set up in the "User Defined Event" menu, configure the actions when an event is triggered. Multiple actions can be set for a single event.

## 5.5.2 User Defined Event

Users can define events up to 4 and configure notifications on the Notification page. Choose an event from the available drop-down options. Click 'Apply' to save the changes.

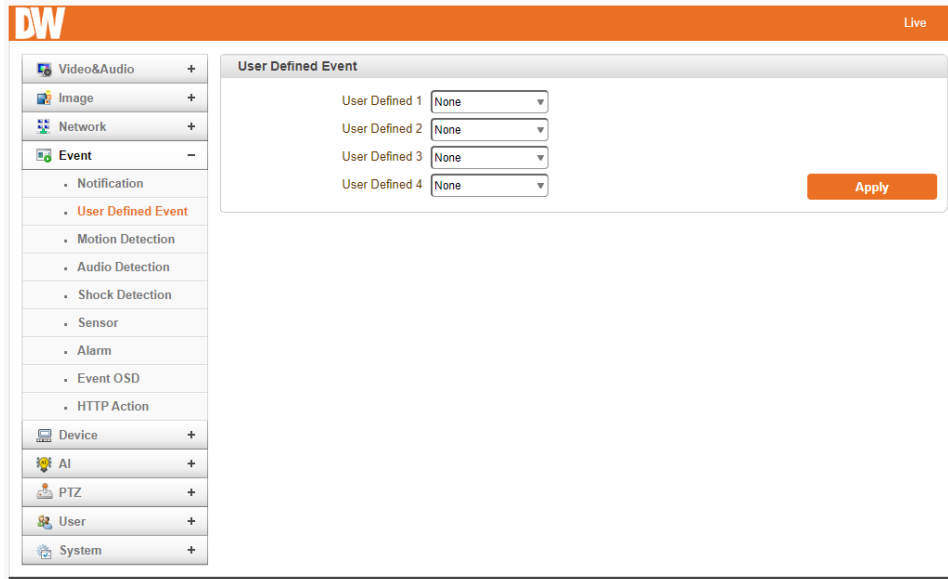

### 5.5.3 Motion Detection

The screenshot displays the DW camera web interface. On the left is a navigation menu with categories: Video&Audio, Image, Network, Event (expanded to show Notification, User Defined Event, Motion Detection, Audio Detection, Shock Detection, Sensor, Alarm, Event OSD, HTTP Action), Device, AI, PTZ, User, and System. The main content area is divided into two sections:

**Motion Detection:** This section has a toggle for "Use Motion Detection" set to "Off" with a "Region-based" sub-option. It features a live video feed of a parking lot. To the right of the feed are eight sensitivity sliders for Region 1 through Region 8, with values ranging from 5 to 10. Below the sliders are "Edit" (Off), "Set", and "Erase" buttons, and an "Apply" button.

**Motion Schedule:** This section has a "Select" dropdown set to "Motion Disable" with "Motion Enable" as an alternative. Below it is a 7x24 grid for scheduling. The columns represent hours from 0 to 23, and the rows represent days of the week from SUN to SAT. The grid is currently empty, indicating motion detection is disabled for all times.

#### Use Motion Detection

Determine to use the **Motion Detection** function.

#### Motion Detection Area Editing

Configure region for motion detection. The following steps can configure regions of arbitrary shape;

1. Select Enable on the Edit tab.
2. Select editing mode. The set is for including cells in the motion detection region, and Erase is for excluding.
3. Select cells by right-clicking. Multiple cells can be selected by pressing and dragging.
4. Press Apply Edit Area to save the setting.

#### Motion Schedule

Users can assign specific days and times when the motion detection regions are active. Blue time blocks indicate motion detection is active. Gray time blocks indicate motion detection is inactive.

### 5.5.4 Audio Detection

The camera can trigger an event when no audio or Audio is detected. To enable, select from the available options in the drop-down menu. The camera can detect Audio or lack thereof.

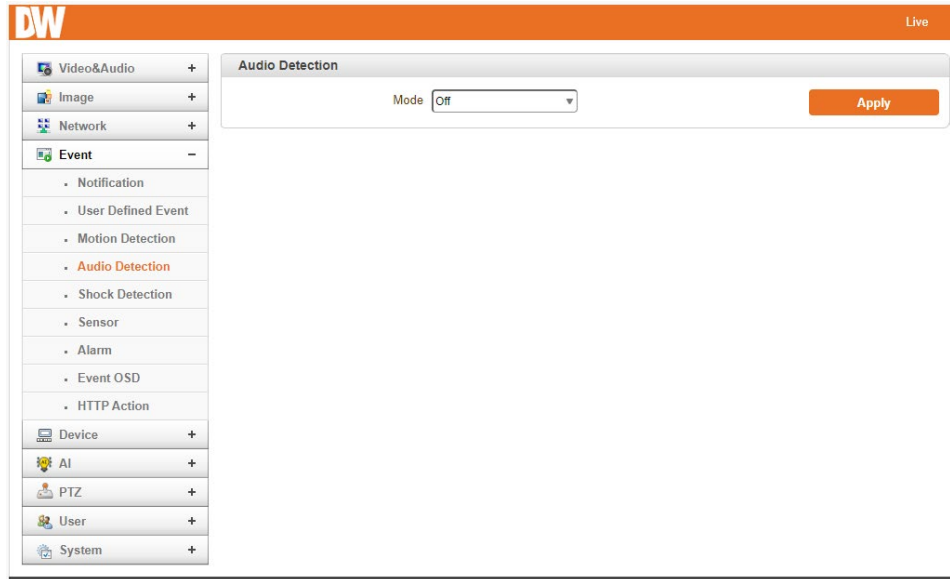

### 5.5.5 Shock Detection

The camera can trigger an event when extreme vibrations or shocks are detected when enabled. Toggle the button to enable. Click 'Apply' to save the changes.

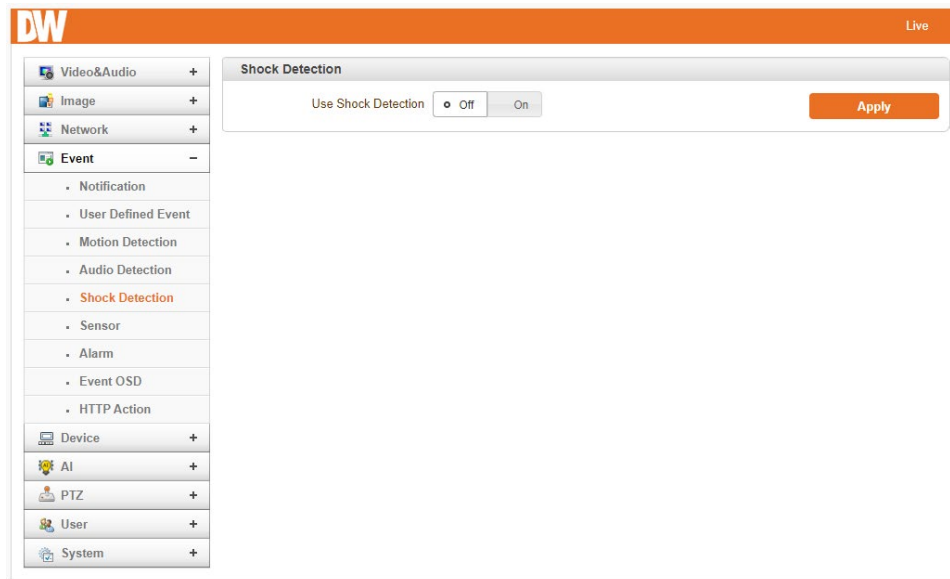

## 5.5.6 Sensor

The screenshot shows the DW camera management interface. On the left is a sidebar menu with categories like Video&Audio, Image, Network, Event, Device, AI, PTZ, User, and System. The main area is divided into two sections: 'Sensor Type' and 'Sensor Schedule'.

**Sensor Type**

Sensor	Off	<input checked="" type="radio"/> N/O	N/C
Sensor 1	<input type="checkbox"/>	<input checked="" type="radio"/>	<input type="checkbox"/>
Sensor 2	<input type="checkbox"/>	<input checked="" type="radio"/>	<input type="checkbox"/>
Sensor 3	<input type="checkbox"/>	<input checked="" type="radio"/>	<input type="checkbox"/>
Sensor 4	<input type="checkbox"/>	<input checked="" type="radio"/>	<input type="checkbox"/>

**Sensor Schedule**

Select:  Sensor Off  Sensor On

**Sensor 1**

	0	1	2	3	4	5	6	7	8	9	10	11	12	13	14	15	16	17	18	19	20	21	22	23	
SUN																									
MON																									
TUE																									
WED																									
THU																									
FRI																									
SAT																									

**Sensor 2**

	0	1	2	3	4	5	6	7	8	9	10	11	12	13	14	15	16	17	18	19	20	21	22	23	
SUN																									
MON																									
TUE																									
WED																									
THU																									
FRI																									
SAT																									

**Sensor 3**

	0	1	2	3	4	5	6	7	8	9	10	11	12	13	14	15	16	17	18	19	20	21	22	23	
SUN																									
MON																									
TUE																									
WED																									
THU																									
FRI																									
SAT																									

**Sensor 4**

	0	1	2	3	4	5	6	7	8	9	10	11	12	13	14	15	16	17	18	19	20	21	22	23	
SUN																									
MON																									
TUE																									
WED																									
THU																									
FRI																									
SAT																									

An orange 'Apply' button is located at the bottom right of the configuration area.

### Sensor Type

There are two sensor input ports on the video server. Each of the sensor ports can be configured to the following:

- Off: not used
- NO (Normally Open): The port is open and activated when closed.
- NC (Normally Closed): The port is normally closed and activated when opened.

The function of the sensor port is set based on the type of the Sensor connected.

### Sensor Schedule

Choose **Sensor OFF** or **Sensor On** and click the below schedule table to make a sensor schedule according to the day of the week and hours.

## 5.5.7 Alarm

Set the duration of alarm or beep activation in case of an event. If it is set to **continuous**, it will be active until the operator resets it manually.

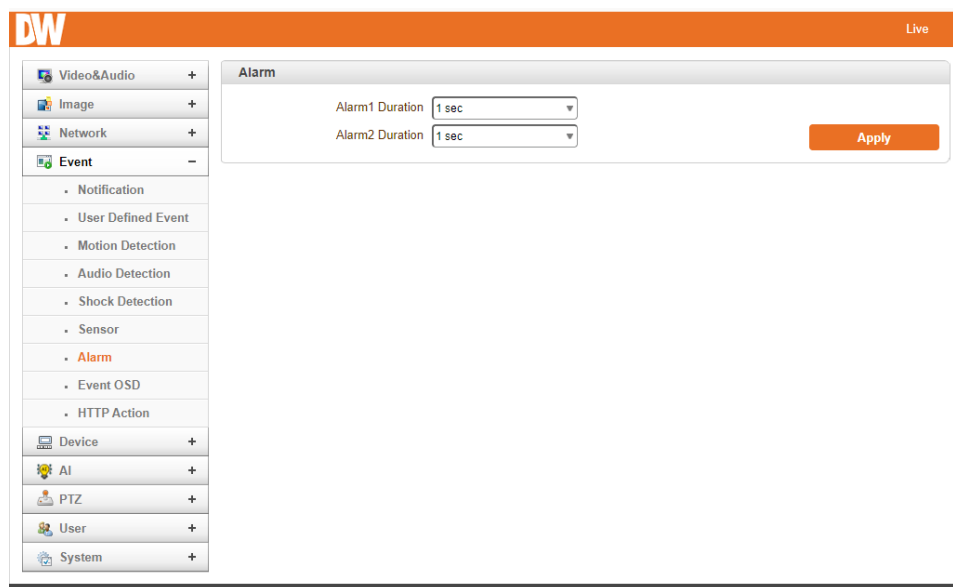

### 5.5.8 Event OSD

According to the event, Event OSD will be displayed. (User should put in comments for displaying). Before starting this feature, please enable Event OSD on the Notification page.

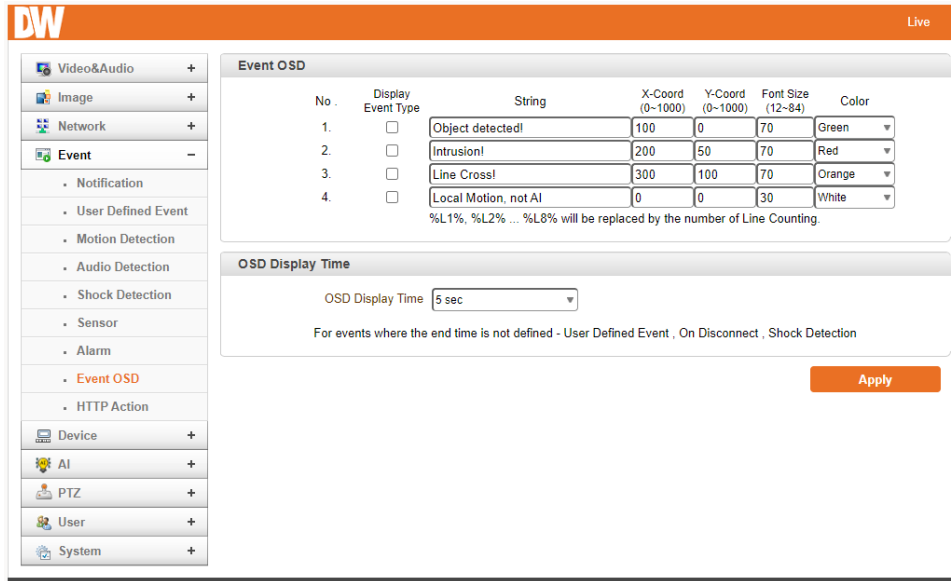

### 5.5.9 HTTP Action

According to Event, TCS-3000 will transmit HTTP API to Device. (User should put in HTTP API). Before starting this feature, please enable HTTP Action on the Notification page.

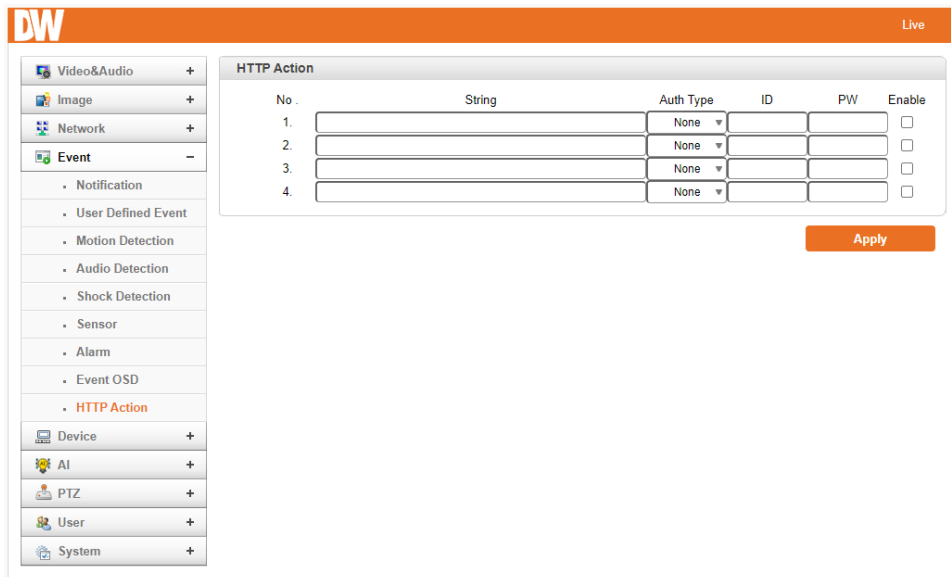

## 5.6 Device

### 5.6.1 Information

The information provides the current serial communication status.

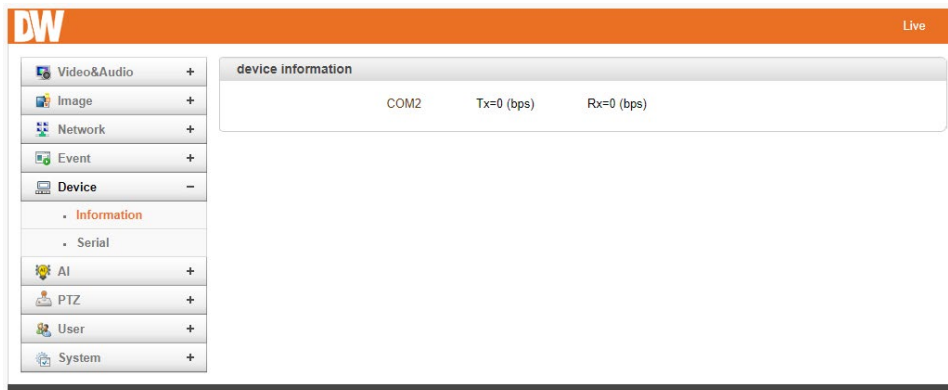

### 5.6.2 Serial

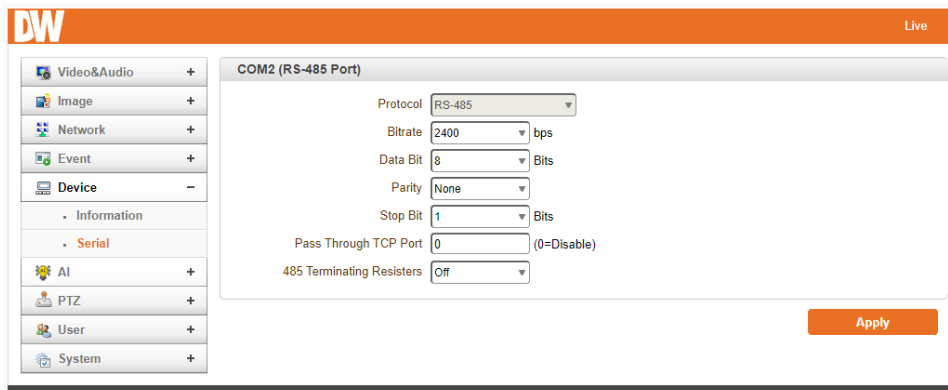

- Serial Protocol: This camera supports one RS-485 serial port.
- Serial Port Configuration: The serial ports can be configured as follows;

Each serial port configuration must be the same as the connecting device.

Mode	Selection
Bitrate	2400, 4800, 9600, 19200, 38400, 57600, 115200 bps
Data Bits	5, 6, 7, 8 bit
Parity	NONE, EVEN, ODD bit
Stop Bit	1, 2 bit



## 5.7 AI

### 5.7.1 AI General

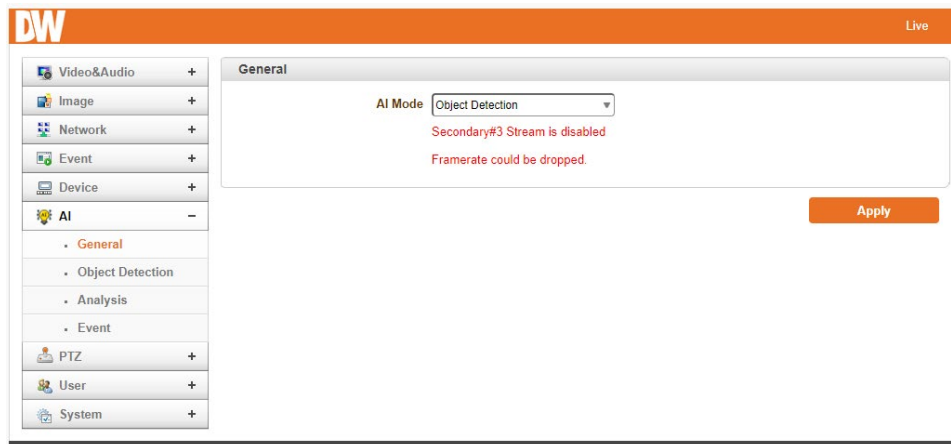

#### AI Mode

- Object Detection: If Object Detection Mode is applied, the LPR tab is disabled.

## 5.7.2 Object Detection

The screenshot displays the DW camera's configuration interface. On the left is a sidebar with menu items: Video&Audio, Image, Network, Event, Device, AI (expanded to General, Object Detection, Analysis, Event), PTZ, User, and System. The main area is titled 'View' and shows a live video feed of a parking lot with several colored bounding boxes around cars and a person. Below the video are zoom and focus controls. The 'Basic' settings section includes a table for object detection:

Object	Display Type	Sensitivity	Smart Object
<input checked="" type="checkbox"/> Person	Box	High	On
<input checked="" type="checkbox"/> Bicycle	Box	High	On
<input checked="" type="checkbox"/> Car	Box	High	On

Below this is the 'Object Size' section with 'Minimum' (381 x 383) and 'Maximum' (2051 x 1366) dimensions. The 'ROI' section has 'Include' and 'Exclude' tabs, a grid of 8 regions, and buttons for Search, Edit, and Set. It also has 'Mode' and 'Direction' dropdowns and 'Object' checkboxes for Person, Bicycle, and Car. An 'Apply' button is at the bottom right.

### Basic

- Type: Choose the type of object detection (Person, Bicycle/motorcycle or Car.)
- Display Type: Choose how the object will be shown.
  - **Box:** After the object is detected, a box will be drawn around it.
  - **Blur:** After the object is detected, the object will be blurred out.
- Sensitive: It determines the sensitivity of the object detection.
  - **Ultra High:** Farther objects on the screen are also detected.
  - **High:** Accuracy and quantity vary depending on scenery, but the detection of objects closer is the priority.
  - **Middle:** Accuracy and quantity varies depending on the scenery.
  - **Low:** More objects are detected but with less accuracy.

## ROI (Include)

Set an area to detect an object.

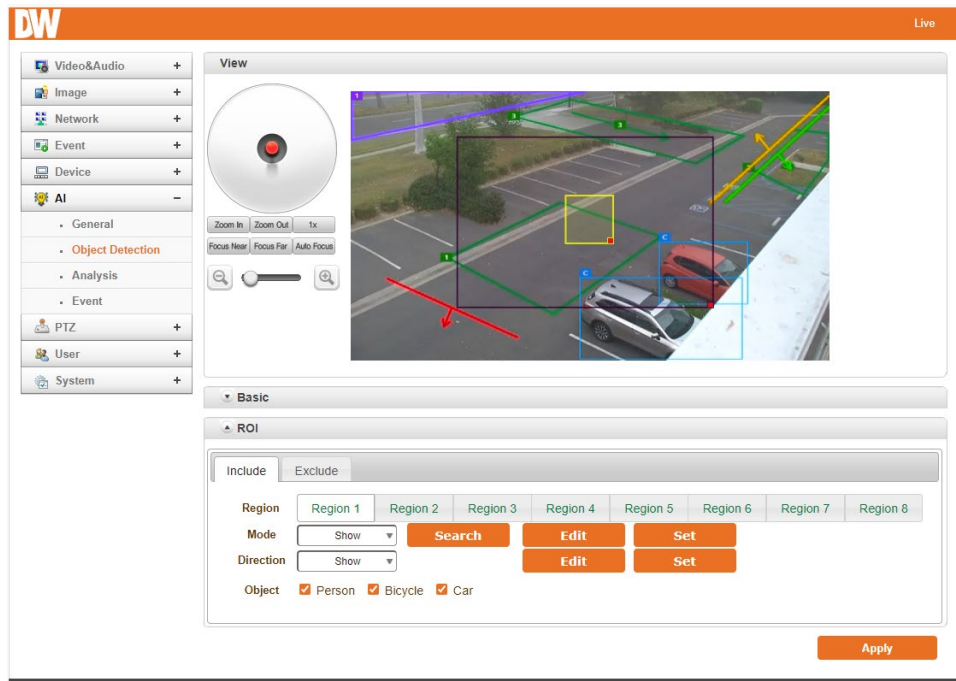

Region: The user can set the area to be detected on the screen (Up to 8 areas can be set)

- Mode:
  - **Off:** Disable ROI.
  - **Show:** Able to select the ROI with area selection on-screen display.
  - **Hide:** Able to select the ROI with area selection but without screen display.

The screen will return to the location where the Region was first selected.

Editing and modifying the desired ROI are on the screen.

Click 'Set' to save the changes.

- Direction
  - **Off:** Disable object movement direction.
  - **Show:** Able to select the Object movement direction on-screen display.
  - **Hide:** Able to select the Object movement direction but without screen display.

Editing and modifying the direction of movement of objects on the screen.

Click 'Set' to save the changes.

- Type: Selectable object (Person, Bicycle, Car) to be detected for each Region.

## ROI (Exclude)

Set an area to exclude from detection any objects.

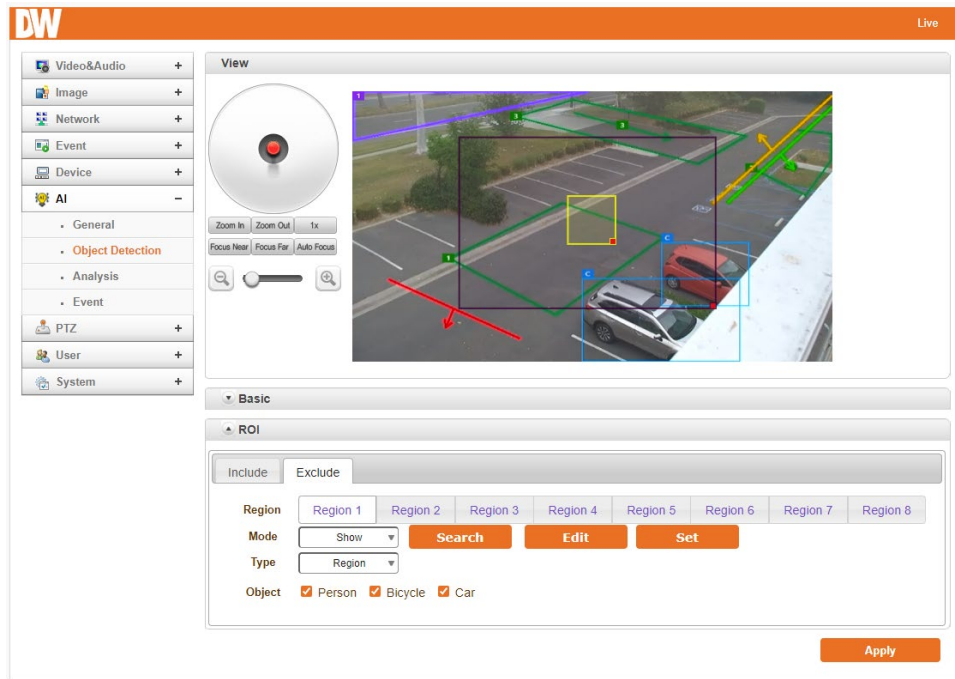

Region: The user can set the area to be detected on the screen (Up to 8 areas can be set)

- Mode:
  - **Off:** Disable ROI.
  - **Show:** Able to select the ROI with area selection on-screen display.
  - **Hide:** Able to select the ROI with area selection but without screen display.

The screen will return to the location where the Region was first selected.

Editing and modifying the desired ROI are on the screen.

Click 'Set' to save the changes.

## Type

Region Operation: Even if an object is detected on the screen inside the Excluded Region, the object detection is ignored. (All objects moving or still inside this Region are not detected.)

### 5.7.3 AI Analysis

#### ROI Event

Region Event: Events can be set for the state of objects by the object type in the area.

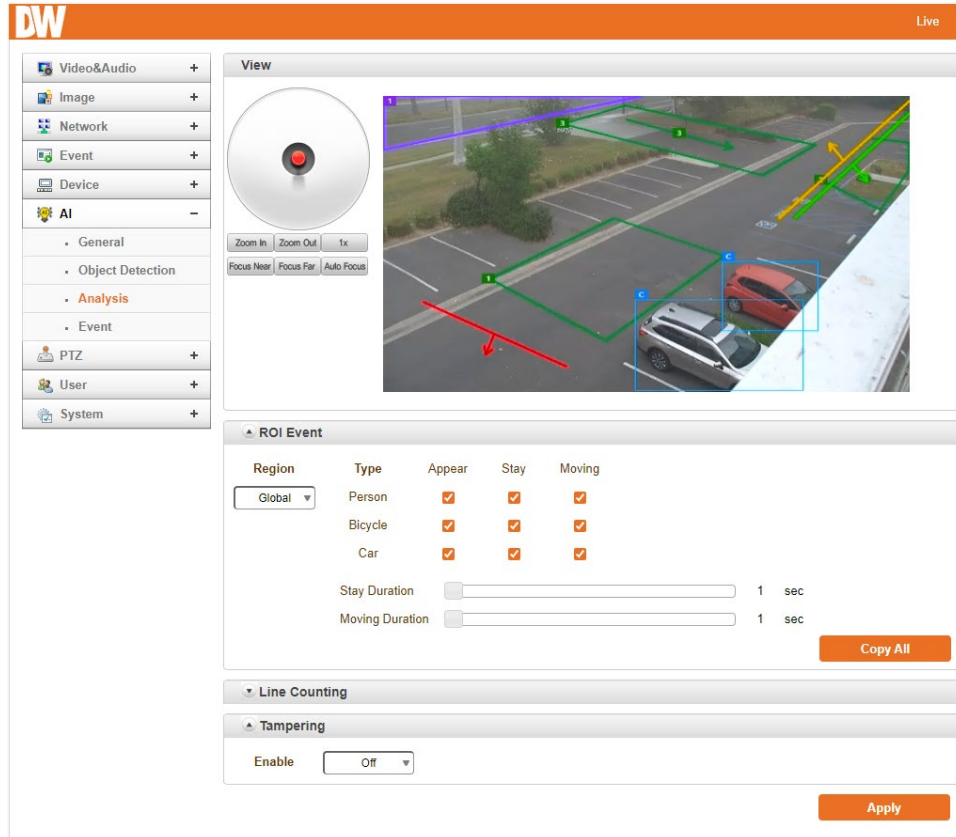

Region: It is configurable for each event for Global or ROI 1-8.

- Type: Each event can be set for people, bicycles (motorcycles), and cars.
  - **Appear:** Objects visible on the screen.
  - **Stay:** Objects that are still (not moving).
  - **Moving:** Moving Objects.
  - **Flow:** Objects moving in a direction.
  - **Intrusion:** Objects coming in from outside the ROI area.
  - **Escape:** Objects leaving from the ROI area.
- Stay Duration: It is possible to set a stationary object's time (1 second to 255 seconds). If the user checks on the Stay event, the event occurs according to the time of the Stay Duration setup. Moving

Duration: It is possible to set a moving object's time (1 second to 255 seconds). If the user checks on the Moving event, the event occurs according to the time of the Moving Duration setup.

## Line Counting

It is the function to count objects passing through the line direction set on the screen.

The screenshot shows the DW camera interface. On the left is a navigation menu with categories like Video&Audio, Image, Network, Event, Device, AI, PTZ, User, and System. The main area displays a live video feed of a parking lot with several colored lines (red, yellow, green, blue, brown, orange, olive, teal) overlaid on it. Below the video feed is the 'Line Counting' configuration panel. This panel includes a table for configuring lines, a 'Count Status' section with 'Reset Count' buttons, and a 'Tampering' section.

Line	Mode	Person	Bicycle	Car	Search	Edit	Set
Red	Show	<input checked="" type="checkbox"/>	<input checked="" type="checkbox"/>	<input checked="" type="checkbox"/>	Search	Edit	Set
Yellow	Show	<input checked="" type="checkbox"/>	<input type="checkbox"/>	<input type="checkbox"/>	Search	Edit	Set
Green	Show	<input checked="" type="checkbox"/>	<input type="checkbox"/>	<input type="checkbox"/>	Search	Edit	Set
Blue	Off	<input type="checkbox"/>	<input type="checkbox"/>	<input type="checkbox"/>	Search	Edit	Set
Brown	Off	<input type="checkbox"/>	<input type="checkbox"/>	<input type="checkbox"/>	Search	Edit	Set
Orange	Off	<input type="checkbox"/>	<input type="checkbox"/>	<input type="checkbox"/>	Search	Edit	Set
Olive	Off	<input type="checkbox"/>	<input type="checkbox"/>	<input type="checkbox"/>	Search	Edit	Set
Teal	Off	<input type="checkbox"/>	<input type="checkbox"/>	<input type="checkbox"/>	Search	Edit	Set

Count Status

Red	14255	Yellow	29	Green	45	Blue	0
Reset Count		Reset Count		Reset Count		Reset Count	
Brown	0	Orange	0	Olive	0	Teal	0
Reset Count		Reset Count		Reset Count		Reset Count	

Reset Time 00:00

Display Line Counting Event OSD continuously.

Line: Lines 1 to 8 can be set for each object

- Mode:
  - **Off:** Disable ROI area.
  - **Show:** Able to select the ROI area and display the lines on the screen.
  - **Hide:** Able to select the ROI area but not display the lines on the screen.

The screen will return to where the line was first set.

- Count Status
  - Displays the number of objects passed by each colored line.
  - Reset the counted number.
  - A function to continuously display on screen the number of object counts.

## **Tampering**

An event occurs when an external physical impact on the camera is dealt with or when the video screen is covered by more than 40%.

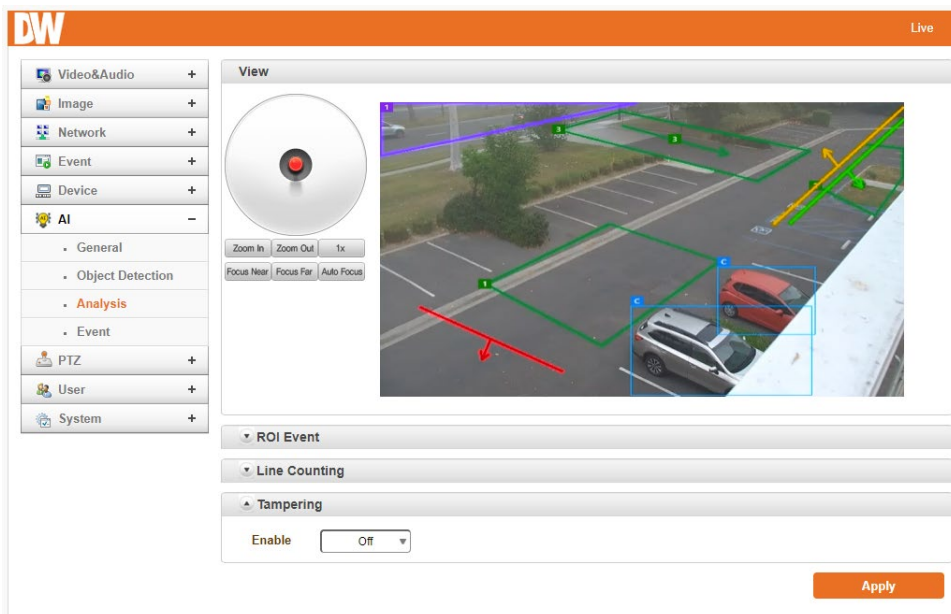

Tampering occurs during motion detection or when the camera is manually moved.

## 5.7.4 AI Event

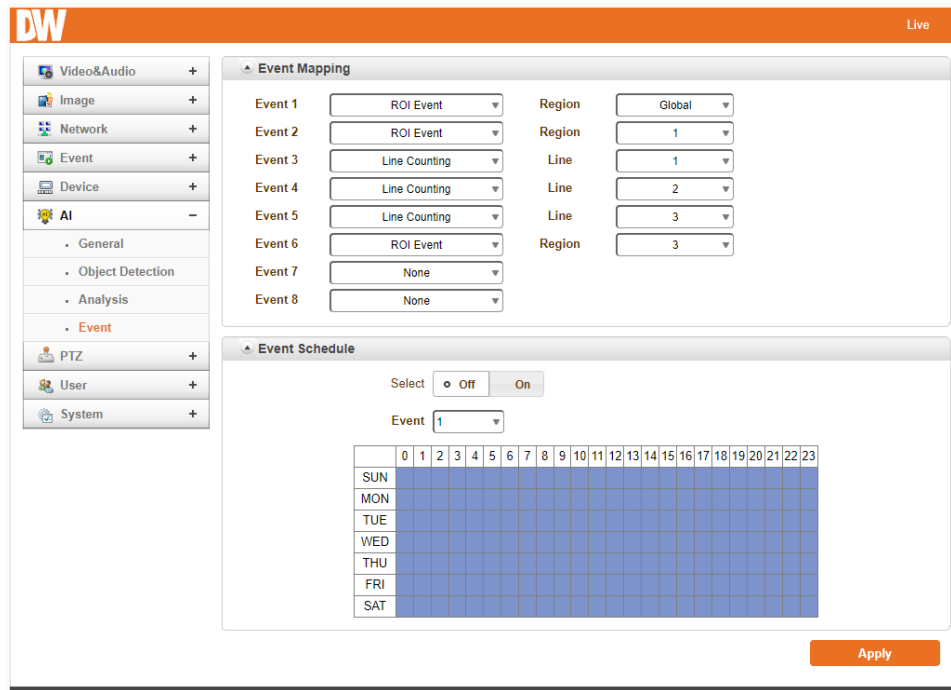

Event Mapping: Each event can be set from Event 1 ~ 8

- Event Type
  - **Region Event:** Include ROI Area (Select between 1-8.)
  - **Line Counting:** Line Counting (Select between 1-4.)
  - **Tampering:** Tampering.
- Event Schedule: Scheduling can be set for each event. (If the Event Schedule is OFF, even if an event is generated according to each event type, selected actions will not be executed).

To Display OSD of Object Detection (Intrusion):

1. Select Object Detection or Combination Mode on AI Mode and press Apply.
2. On Basic, choose the Type, Display Type and Sensitivity.
3. Modify the ROI settings for the desired outcome.
4. Press Apply.
5. Choose the Event type (Duplicate selection is available.)
6. On Event, Select on Region Event and the ROI.



7. Go to the Event Tab, and on String, write the desired words, and select the coordinates and the color.
8. Press Apply.
9. Select the Event OSD desired.
10. Press Apply.

## 5.8 PTZ

### 5.8.1 General

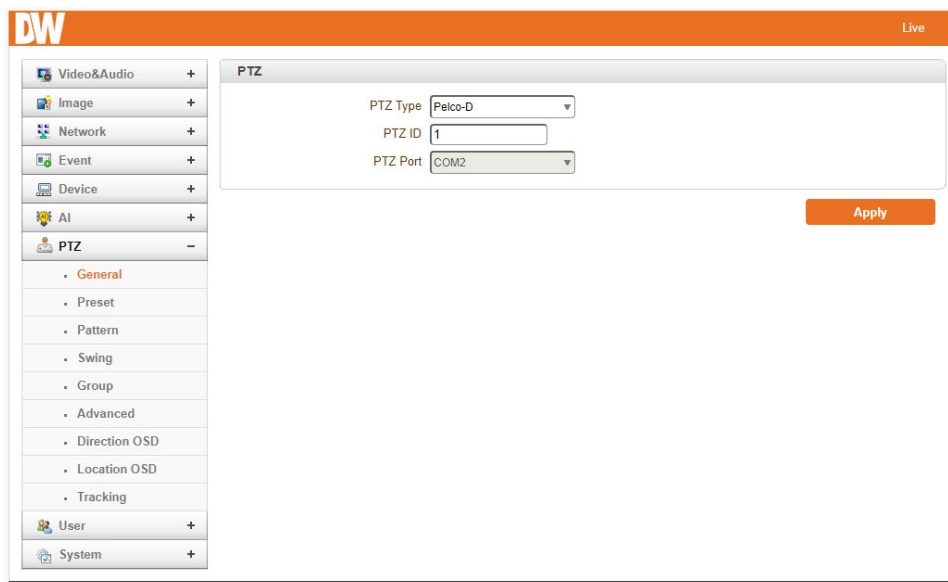

- PTZ Type: Select the type of PTZ camera or receiver.
- PTZ ID: Since it is possible to control multiple PTZ cameras or receivers over a single control line, each camera or receiver will be assigned a unique ID. Enter the PTZ ID of a camera or receiver to control. The ID value range can be between 0 and 255.
- PTZ Port: Select the serial port for PTZ camera control.

## 5.8.2 Preset

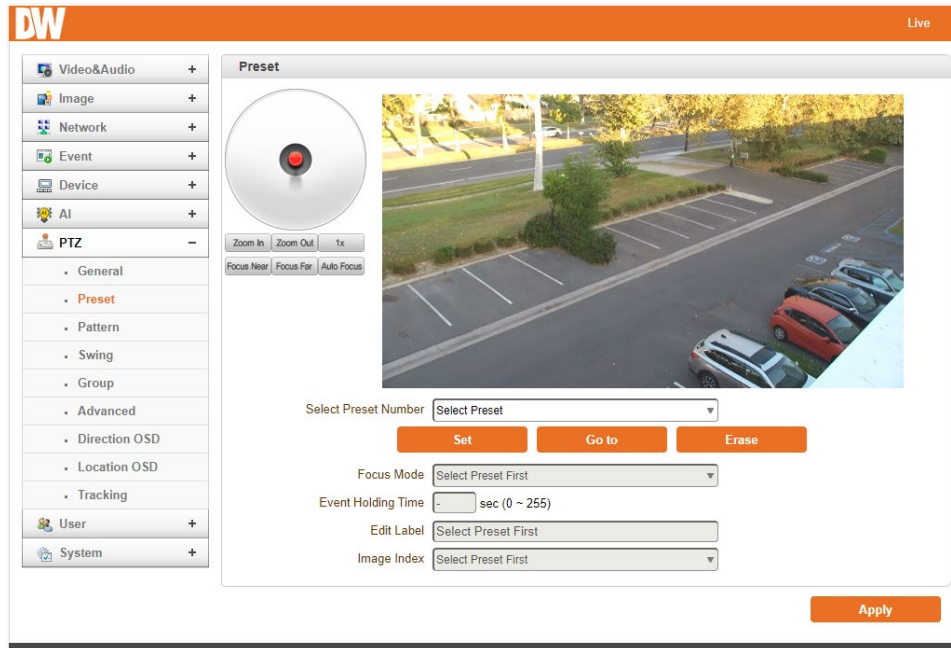

Max 128 preset positions can be defined.

- Select Preset Number: Select an entry in the list to be assigned to the current camera position.
  - Focus Mode: Select the focus mode after the preset Goto is executed.
  - Do not change: The current focus mode is not changed.
  - Focus Auto: auto-focusing is executed after the preset is moved.
  - Focus Manual: move to the focus position saved when preset set.
- Event Holding Time: Set the time to stay at the preset position when the event moves the preset. If set to 0, the camera doesn't return to the original position after moving to the preset position by event.
- Edit Label: Assign a label to the preset position. Only the first 15 preset entries (Preset-1 ~ Preset-15) can have labels.

### 5.8.3 Pattern

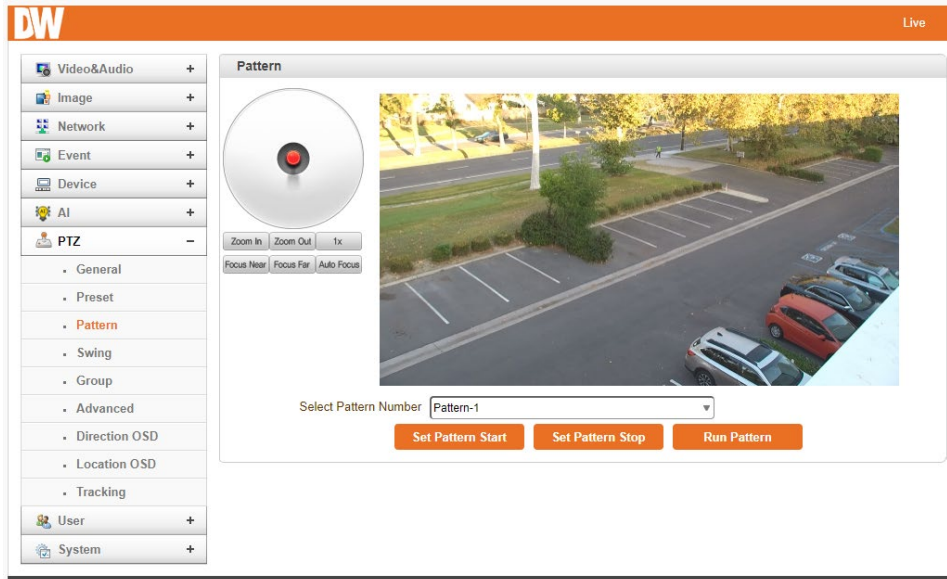

Max. 4 of Patterns can be recorded and played back. This enables to move camera to follow any trajectory operated by a joystick as closely as possible.

## 5.8.4 Swing

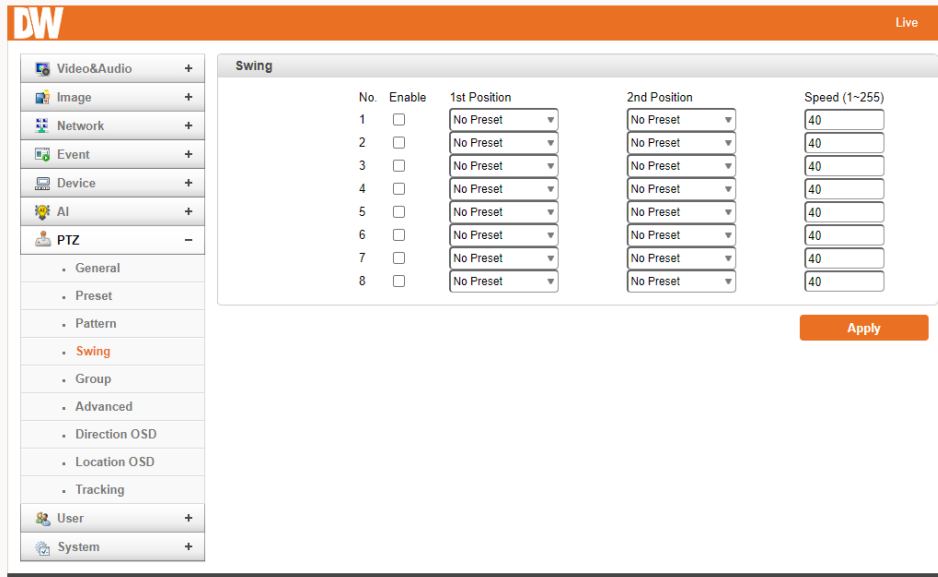

Using the swing function, you can make the camera move between 2 preset positions repeatedly. When the swing function runs, the camera moves from the preset assigned as the 1st point to the preset assigned as the 2nd point in the CW(Clockwise) direction. Then, the camera moves from the preset assigned as the 2nd point to the preset assigned as the 1st point in the CCW (Counterclockwise) direction.

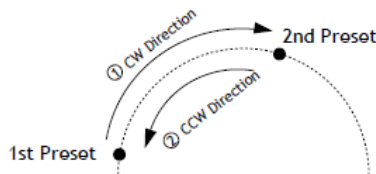

In case the preset assigned as the 1st point is the same as the preset assigned as the 2nd point, the camera turns on its axis by 360° in CW(Clockwise) direction and then it turns on its axis by 360° in CCW(Counterclockwise) direction.

1. Check the **Enable** box.
2. Select the Preset for **1st Position** and **2nd Position**.
3. Enter the **speed** (0~255).
4. Press the **Save Swing** button to save.

### 5.8.5 Group

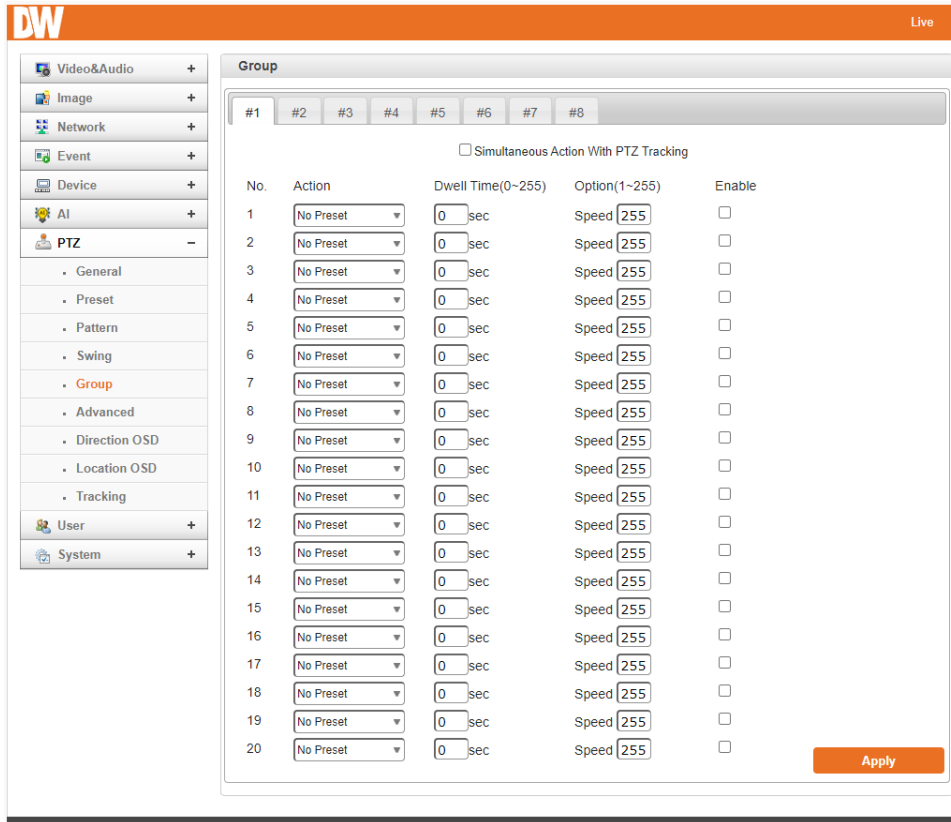

This function is that the camera memorizes the combination of Presets, Pattern and/or Swings sequentially and runs Presets, Pattern and/or Swings repetitively on activation. Max 8 groups are programmable. Each group can have a max of 20 actions, which are the combinations of Preset, Pattern and Swing. The option field has different meanings for Preset and Pattern/Swing. For Preset, it configures the preset speed. For Pattern/Swing, it configures the number of repetitions. Dwell time between actions can be set up as well.

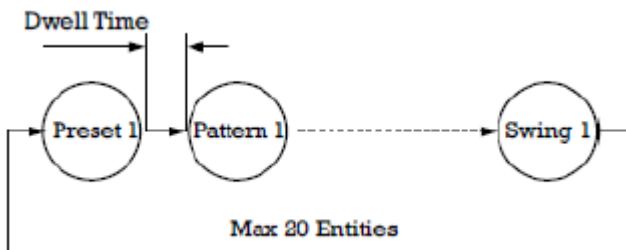

1. Select one of the entries of the group.
2. Press the Modify Group button. The following window will appear.
3. Set Action, Dwell Time and Option and click Enable squares.
4. Press Apply to save the group.

Group							
#1	#2	#3	#4	#5	#6	#7	#8
No.	Action	Dwell Time(0~255)		Option(0~255)		Enable	
1	Preset-1	54	sec	Speed	77	<input checked="" type="checkbox"/>	
2	Preset-6	5	sec	Speed	124	<input checked="" type="checkbox"/>	
3	Preset-127	23	sec	Speed	55	<input checked="" type="checkbox"/>	
4	Preset-21	23	sec	Speed	43	<input checked="" type="checkbox"/>	
5	No Preset	0	sec	Speed	0	<input type="checkbox"/>	

## 5.8.6 Advanced

The screenshot displays the 'Advanced' settings page for a DW PTZ camera. The interface is organized into three main sections:

- Advanced:** Contains settings for Max Jog Speed (120 degree/sec), Max Zoom Speed (5), Max Position Move Speed (30), Freeze on Position Move (Off), Zoom Proportional Jog (Off), Auto Flip (Off), Prevent Auto PTZ (Off), Display PTZ Action (Off), Display Zoom Magnification (Off), Power Up Action (Off), Auto Focus after Zoom Control (Off), One Shot AF after PTZ (Off), AF Sensitivity (3), AF Area (Auto), and Motion Detection and Tampering disable on PTZ (Off). A 'Ventilation' button is also present.
- Calibration:** Features a 'Run' button and an 'Auto Calibration' toggle (Off).
- Auto Parking:** Includes a 'Parking Time' field (0 sec), four 'Parking Action' dropdown menus (all set to 'No Preset'), and a 'Schedule of Auto Parking' calendar. The calendar shows days of the week (SUN to SAT) and hours (0-23).

An 'Apply' button is located at the bottom right of the interface.

### Advanced

- Max Jog speed: There are eight levels of zoom speed.
- Max zoom speed: There are eight levels of zoom speed.
- Free on Position Move: During PTZ operating, stopped video before PTZ operating is showing on the display. Once the PTZ operation is stopped, the video is changed to the current position.
- Zoom Proportional Jog: When Zoom Proportional Jog is on, the Pan/Tilt speed can be set automatically after zooming in.
- Auto Flip:

- **On:** in case that tilt angle arrives at the top of tilt orbit, the camera turns 180 degrees at the top and moves in the opposite direction to keep tracking targets.
- **Off:** more than 90 degrees tilt moving is not available.
- Display PTZ Action: PTZ control actions such as Preset Goto, Pattern, Swing or Group can be displayed on the top of the live display as the information is displayed with burn-in OSD. It is inserted into the encoded stream; all clients can see the information.
- Digital Zoom Magnification: Display zoom ratio.
- Power Up Action: Specify if the camera will continue the previous action, such as pattern, swing or group, after it is rebooted by power.
  - Group-1: When it will reboot, start to Group-1
  - Preset-1: When it will reboot, start to Preset-1
  - Off: Moves to the initial position after rebooting.
- Auto Focus after Zoom control: the camera zooms in and out of the view, and the focus will adjust automatically once the zoom stops moving.
- One Shot AF after PTZ: when the camera's pan, tilt and zoom are done working, the autofocus will work automatically.
- Motion Detection and Tampering Disable on PTZ: Disable the motion detection and tampering when the camera's pan, tilt and zoom are working.

### **Auto Parking**

Auto parking is a function to return to the previous preset position or to resume operation such as Pattern, Swing or Group when a specified time expires after the user stopped PTZ control. Parking time can be set from 0 to 3600 seconds, and "0" means the Auto Parking function is turned off.

- **Parking Time:** Performs the *Parking Action* after the set time has been reached, if there is no command. This will trigger automatic tracking even if other commands such as *Jog Control Action*, *Go Preset*, etc. are executed.
- **Parking Action:** Allows to set group presets and enable tracking on a schedule (hour of day, day of week).



## 5.8.7 Direct OSD (ONLY PT System)

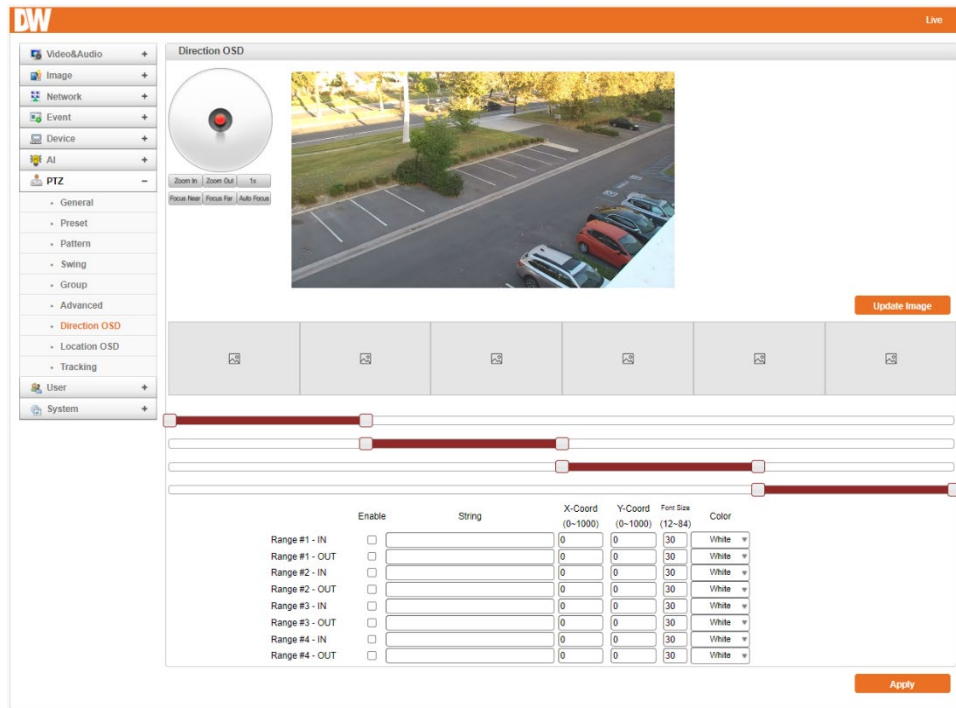

- 360-degree panoramic shot.
- Users can select the area in the camera's view to display the OSD.
- Range # - In: According to the coordinate value, users can see specific OSD.
- Range # - On: regardless of coordinate value, users can see specific OSD.
- X - Coord: Position of horizontal.
- Y - Coord: Position of vertical.
- Font size: Font size.
- Hue: Color.

## 5.8.8 Location OSD

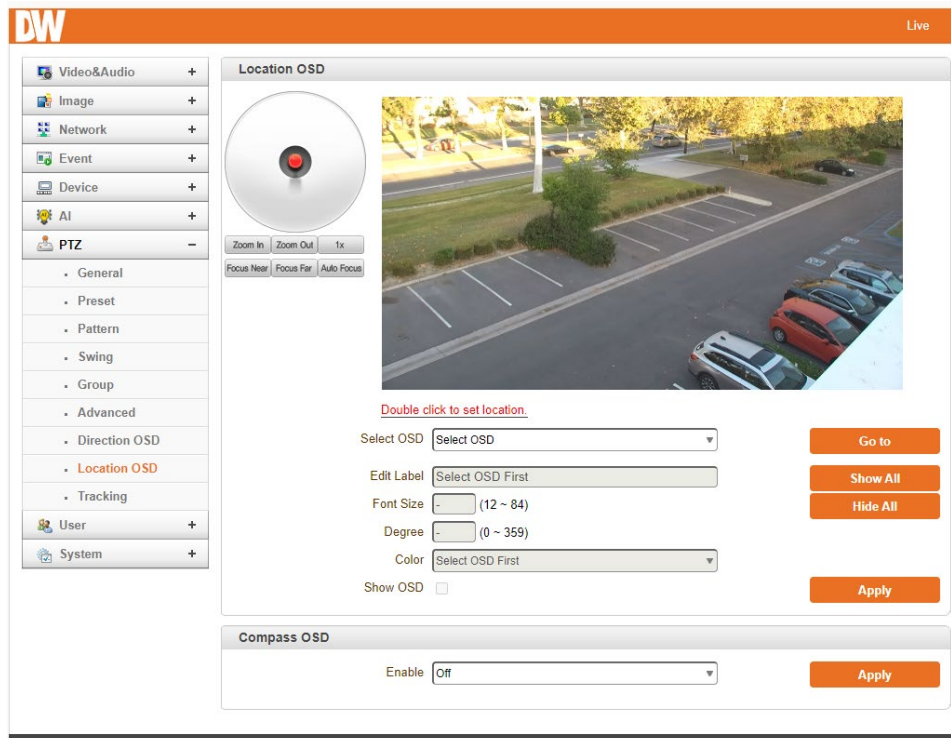

Users can find the registered OSD and even move to a specific location.

Users can even edit the Label of the OSD and change font size, degree and color.

By checking on the "Show OSD," the user can continuously maintain the OSD on screen.

Compass the position of the OSD by entering the X and Y coordinates.

Select the background desired or use the default background by turning it off.

## 5.8.9 Tracking

The camera provides a Tracking feature according to motion detection and AI.

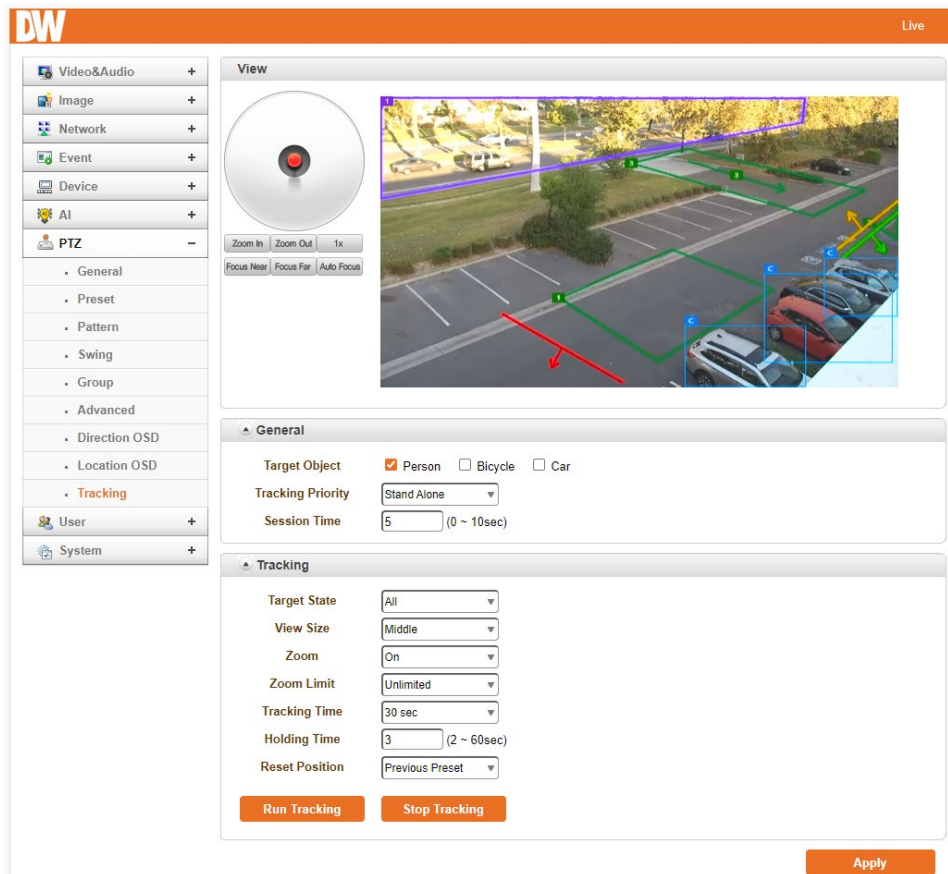

### General

- **Target Object:** Choose the type of Object to track.
- **Tracking Priority:**
  - **Stand Alone:** Recognizes and tracks objects within the field of view.
  - **External Tracking:** When an object or motion is detected by a fixed camera (bullet, etc.) that is installed on the same pole as the PTZ camera, the coordinate information that is detected by the fixed camera is sent to the PTZ camera so that it can orient itself to the coordinates to track the new detection.
- **Session Time:** External Tracking setting for how long to wait (seconds) for the PTZ after an object has disappeared from the fixed camera's (bullet, etc.) view. This is similar to the *Holding Time* setting.

### Standalone Tracking

- **Target State:** Decide the target state of the object.

- **Moving/Stay:** Tracking progresses when a detected object moves or stays for the set time after detection.
- **Flow:** Tracks objects that move in the direction of the Ai ROI (region of interest) Direction.
- **View Size:** Size desired to be shown on the screen. Select whether to keep the size of objects on the PTZ screen as large (zoomed-in), medium or small (wide) while tracking objects.
- **Zoom:** Availability of zoom integration.
- **Zoom Limit:** Decide the zoom limit for the camera to zoom in. Set whether to use the zoom-in function when an object moves away, as well as how far to increase magnification.
- **Tracking Time:** Decide how much time the camera will follow the object. Determines how long to keep tracking an object after it has been detected (infinite, 10 sec, 30 sec, 1 min, 2 min, 3 min, 5 min, 10 min).
- **Holding Time:** Set how long the PTZ camera should remain pointed at a coordinate after an object that it has been tracking disappears or is no longer detected.
- **Waiting Time:** The time to wait for the next object tracking.
- **Reset Position:** Return to the preset position after the *Holding Time* has been reached after a tracked object disappears.
- **Run Tracking:** Track the objects with the above setups. *Run Tracking* is a one-time command and if a jog control action or other command to redirect the camera, *Run Tracking* will stop.
- **Stop Tracking:** Stop tracking.

## 5.9 User

### 5.9.1 User List

The screenshot displays the 'User List' management interface. On the left is a navigation menu with categories like Video&Audio, Image, Network, Event, Device, AI, PTZ, User, and System. The 'User List' option is expanded. The main area shows a table with the following data:

ID	Privilege Level	
admin	Admin	

Below the table are four action buttons: Add, Delete, Modify Password, and Modify Privilege.

Users can be registered and specify the privilege level of a user. User configuration is allowed only to the admin user. A maximum of 16 users can be registered, each with one of four privileges.

Privilege	Allowed Operations	Remarks
Admin	All operations	User ID = admin
Manager	All operations except for user configuration	
User	Live viewing and PTZ control	
Guest	Live viewing only	

- Add User: Press the **Add** Button. The following window will appear.

Enter the User ID and password (Up to 15 characters) and select **Privilege Level**.

- Delete User: Select the User to be deleted and press the **Delete** button.
- Change Password: Press the **Modify Password** button. The following window will appear.

Enter the current password and then set a new password.

- Modify Privilege Level: Press the **Modify Privilege** button to change the User level. It is not allowed to change the privilege level of the admin user.

**Modify Privilege Level** ✕

ID

Privilege Level

## 5.9.2 Login Policy

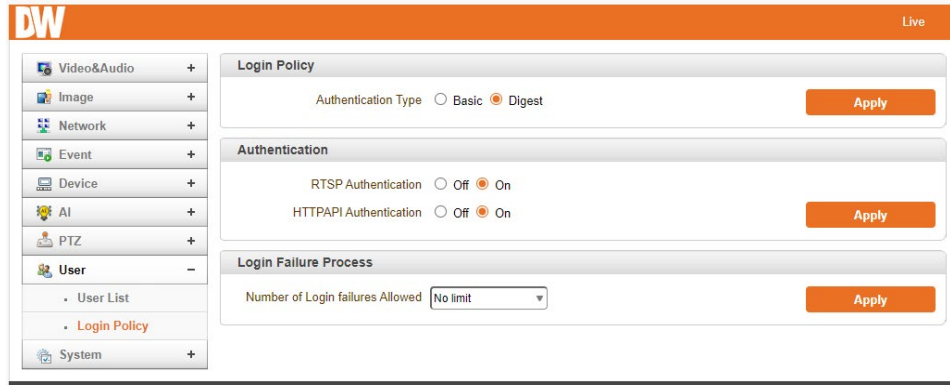

### Login Policy

- **Skip Login** provides convenient access to the server when authentication is not required. When Skip Login is set to **Enable**, the login step is skipped. The setting of Privilege Level determines the privilege level after login **after the login is skipped**.
- Authentication: HTTP authentication based on RFC 2617(HTTP Authentication: Basic and Digest Access Authentication) is supported.

## 5.10 System

### 5.10.1 Information

The screenshot shows the DW camera web interface. The top bar is orange with the DW logo on the left and 'Live' on the right. A left sidebar contains a menu with categories: Video&Audio, Image, Network, Event, Device, AI, PTZ, User, and System. The System category is expanded, showing sub-items: Information (highlighted in red), Upgrade&Reboot, Time, OSD, Language, and Log. The main content area is titled 'System Information' and displays the following details:

Model	DWC-XPZA08Mi (4E073)
IP FW Version	V13.309B10_T857
PTZ FW Version	AD (173)
Zoom Module Version	114031610806
ONVIF Version	21.12
OpenSSL Version	OpenSSL 1.1.1j 16 Feb 2021
AI Version	D230630 B230622 L230706
MAC Address	00:1C:63:D4:59:D0
IP Address	192.168.15.72
Domain Name	Not RegisteredB
Input Power	PoE
Video Analysis Status	License valid, Video analysis activated.

#### System information

Followed network information is displayed (Read only)

- Model: Display the model name.
- Version: Display the current firmware version.
- Mac Address: Display the MAC address of the camera. If the camera is registered at the DDNS server, the MAC address is used in DDNS registration.
- Set Current Time: Display Current date and time
- Current Domain: In case the camera is registered at the DDNS server, the registered domain name is displayed.



## 5.10.2 Upgrade and Reboot

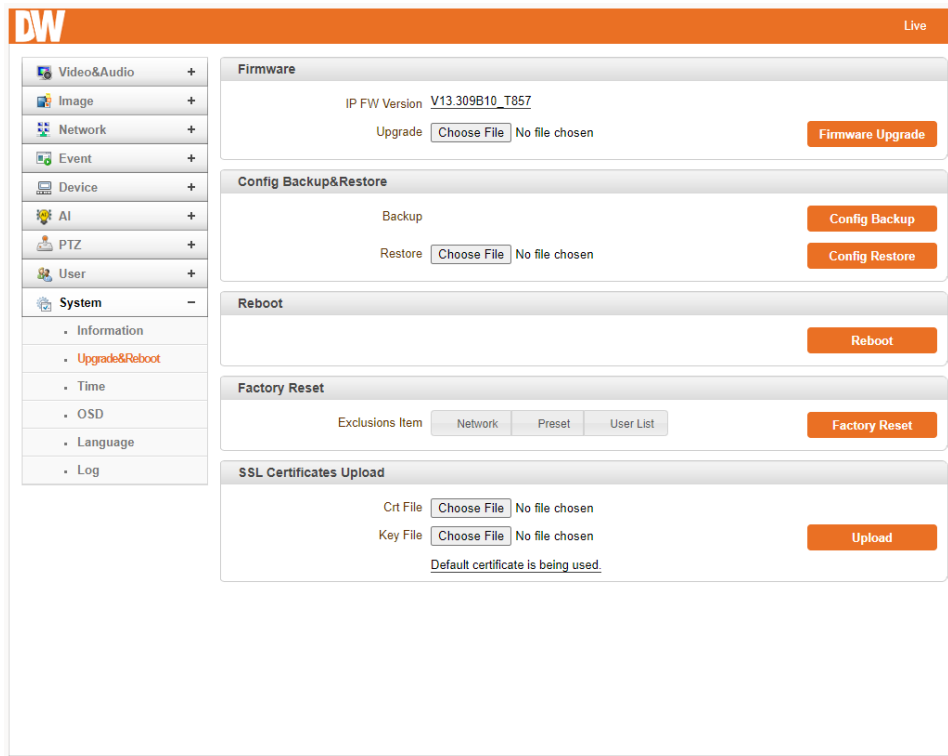

### Firmware

- Version: Display the current firmware version. Upgrade: To upgrade firmware;
  1. Press the '**Browse**' button to select a firmware file from the PC.
  2. Press the '**Firmware Upgrade**' button to start upgrading.
  3. A message showing the status (downloading / upgrading) will be displayed.
  4. The camera will reboot automatically after completing the upgrade.

Do not turn the camera off during upgrading.

### Config Backup & Restore

- Backup: All the settings of the configuration can be stored.
- Restore: Stored configuration can be browsed and restored. The server is rebooted once the **Config Restore** button is pressed.

### Reboot

- Reboot the camera: Do not press the Reboot button unless the server needs a reboot.

## Factory Reset

When selected, the camera will perform a complete factory reset of all settings, including network, PTZ settings and users list, to their default settings. To exclude any specific settings, check the box next to the settings to exclude them. Click 'Factory Reset' to apply.

### 5.10.3 Time

The screenshot shows the 'Time' configuration page in the DW camera web interface. The sidebar on the left lists various settings categories, with 'System' expanded to show sub-options like Information, Upgrade&Reboot, Time, OSD, Language, and Log. The main 'Time' section includes:

- Start Time:** 2023/09/20 9:01:59
- Current Time:** 2023/09/26 7:59:47
- Set Time:** 2023/09/26 7:59:44 (with spinners for each component)
- Time Format:** YYYY/MM/DD hh:mm:ss
- Time Zone:** (GMT-08:00) Pacific Time (US & Canada)
- Automatically adjust clock for Daylight Saving Time
- Automatically synchronize with NTP server
- NTP Server:** pool.ntp.org

- **Start Time:** It is set to the latest camera booting date and time.
- **Current Time:** Current date and time. Enter a new date and time, then press the **Set Current Time** button to update the date & time.
- **Time Format:** Change the time format. The selectable time formats are as follows;
  - YYYY/MM/DD hh:mm:ss (Eg. 2012/10.30 12:30:45.)
  - DD/MM/YYYY hh:mm:ss (Eg. 10/30/2012 12:30:45.)
  - MM/DD/YYYY hh:mm:ss (Eg. 30/10/2012 12:30:45.)
- **Time Zone:** Select the time zone where the camera is installed. Depending on the time zone, Daylight Saving Time will work automatically.
- **Automatically synchronized with NTP server:** Synchronize the camera time with an NTP server using NTP (network time protocol). The name of the NTP server should be registered on the NTP server Name.

### 5.10.4 OSD

The screenshot shows the DW camera web interface with the following sections:

- System ID:** A text input field for the System ID.
- Burn-in OSD:**
  - System ID:  Off  On
  - Time:  Off  On
  - Position:  Bottom  Top
  - Font Size:
- User-defined Burn-in OSD:** A table with 4 rows for defining custom OSD strings.
 

No.	String	X-Coord (0~1000)	Y-Coord (0~1000)	Font Size (12~84)	Color	Enable
1	<input type="text"/>	<input type="text" value="0"/>	<input type="text" value="0"/>	<input type="text" value="30"/>	<input type="text" value="White"/>	<input type="checkbox"/>
2	<input type="text"/>	<input type="text" value="0"/>	<input type="text" value="0"/>	<input type="text" value="30"/>	<input type="text" value="White"/>	<input type="checkbox"/>
3	<input type="text"/>	<input type="text" value="0"/>	<input type="text" value="0"/>	<input type="text" value="30"/>	<input type="text" value="White"/>	<input type="checkbox"/>
4	<input type="text"/>	<input type="text" value="0"/>	<input type="text" value="0"/>	<input type="text" value="30"/>	<input type="text" value="White"/>	<input type="checkbox"/>
- User-defined Bitmap OSD:**
  - Bitmap OSD1 Enable:
  - Bitmap OSD2 Enable:

An **Apply** button is located at the bottom right of the configuration area.

#### System ID

Enter the System ID that is used as a camera title.

The set System ID is displayed with a video image on a Web Browser. The System ID is also transferred to remote software, such as VMS, and displayed on it.

#### Burn-In OSD

Insert system ID and date/time **in the compressed video**. System ID and time can be turned on or off in the video. Position and Font size can also be configured. System ID for BurnIn OSD exists independently from normal System ID.

#### User-Defined Burn-in OSD

You can enter any text you like independently.

- X-Coordinate or Y-Coordinate

#### User-Defined Bitmap OSD

Note that the Burn-In OSD display size varies according to the encoding resolution setting. This is inevitable because Burn-In OSD is inserted into the frames before encoding is performed. The following table describes the rule for Burn-In OSD display.

Resolution <sup>↕</sup>	Small (8x8) <sup>↕</sup>	Middle (16x16) <sup>↕</sup>	Large (32x32) <sup>↕</sup>
352x480 / 352x240 / 352x576 / 352x288 <sup>↕</sup>	2 <sup>↕</sup>	1 <sup>↕</sup>	0 <sup>↕</sup>
720x480 / 720x240 / 720x576 / 720x288 / <sup>↕</sup> 640x480 / 800x600 <sup>↕</sup>	2 <sup>↕</sup>	2 <sup>↕</sup>	1 <sup>↕</sup>
1024 x 768 / 1280x720 / 1280 x 960 / 1280x1024 / 1440x900 / 1600x900 / 1680x1050 / 1920x1056 / 1920x1080 / 2048x1536 / 2560x1600 / 2592x1936 <sup>↕</sup>	2 <sup>↕</sup>	2 <sup>↕</sup>	2 <sup>↕</sup>

- 2: Both System ID and Time are displayed
- 1: Either System ID or Time can be displayed. When both are enabled, the System ID is displayed.
- 0: No items are displayed. This is because the video area is too small to display OSD text in large text.

### 5.10.5 Language

Select the preferred language to be used for web-based configuration.

The screenshot shows the DW web-based configuration interface. On the left is a navigation menu with categories: Video&Audio, Image, Network, Event, Device, AI, PTZ, User, and System. The System category is expanded to show sub-items: Information, Upgrade&Reboot, Time, OSD, Language (highlighted in red), and Log. The main content area is titled 'Language' and contains a dropdown menu labeled 'Language' with 'English' selected. An orange 'Apply' button is located to the right of the dropdown. The top right corner of the interface shows the word 'Live'.

## 5.10.6 Log

The screenshot displays the DW Video Server web interface. On the left is a sidebar menu with the following items: Video&Audio (+), Image (+), Network (+), Event (+), Device (+), AI (+), PTZ (+), User (+), System (-), Information, Upgrade&Reboot, Time, OSD, Language, and Log. The main content area is titled 'System Log' and contains a large empty box for log entries. Below this box is a filter bar with checkboxes for Backup, Account, Environment, System, PTZ, Etc, and Connection. At the bottom of the System Log section are three buttons: Get System Log, Save System Log, and Delete System Log File. Below the System Log section is the 'User Log' section, which also contains a large empty box and three buttons: Get User Log, Save User Log, and Delete User Log File. At the bottom is the 'Save Log Option' section, which features a table with columns for 'Include' and 'Exclude' and radio buttons for each category.

	Include	Exclude
User	<input checked="" type="radio"/>	<input type="radio"/>
Backup	<input checked="" type="radio"/>	<input type="radio"/>
Account	<input checked="" type="radio"/>	<input type="radio"/>
Environment	<input checked="" type="radio"/>	<input type="radio"/>
System	<input checked="" type="radio"/>	<input type="radio"/>
PTZ	<input checked="" type="radio"/>	<input type="radio"/>
Etc	<input checked="" type="radio"/>	<input type="radio"/>
Connection	<input type="radio"/>	<input checked="" type="radio"/>

### System Log

Video Server's log can be shown and saved as a txt file. Various filters could be selected.

### User Log

The user (Client) log can be shown and saved as a txt file.

### Save Log Option

Various options can be included or excluded.

## Specifications

	DWC-XPZA03Mi	DWC-XPZA08Mi
<b>IMAGE</b>		
Image sensor	3MP 1/1.8" Star-Light Plus™ sensor	4K 1/1.8" Star-Light Plus™ sensor
Active pixels	2304 (H) x 1296(V)	3840 (H) x 2160(V)
Minimum scene illumination	0.005 lux (color)	
	0 lux (B/W)	
<b>LENS</b>		
Focal length	6.5-260mm, F1.4	
Lens type	Vari-focal lens with motorized zoom and auto-focus	
Horizontal Field of view (HFOV)	1.6°-64.1°	
Vertical Field of view (VFOV)	0.83°-33.4°	
IR distance	1184ft range	
Optical zoom / digital zoom	40x optical zoom, 16x digital zoom	
<b>I/O</b>		
Audio input/output	1 input/ 1 output	
Audio compression	G.711	
Alarm input/output	4x sensor input / 2x alarm output / 1x RS485 port	
Event trigger	Motion alarm, sensor input, client disconnection	
<b>OPERATIONAL</b>		
Shutter mode	Auto, manual, slow Shutter	
Shutter speed	1/1 - 1/100,000	
Slow Shutter	N/A	
Auto gain control	Auto	
Day and night	TDN, Auto, day (color), night (B/W)	
3D Digital Noise Reduction	Smart DNR™ 3D-DNR	
Wide Dynamic Range (WDR)	True WDR	
White balance	Yes	
Privacy zones	8 programmable privacy masks	
Backlight compensation (BLC)	Yes	
Mirror and flip	Yes	
Alarm notifications	Notifications via email, FTP, alarm output, OSD alert, PTZ preset, recording, HTTP action	
<b>PTZ FUNCTION</b>		

Pan range	360°(endless)	
Pan speed	Max speed: 250°/sec,Manual speed: 0.065°/sec ~ 250°/sec	
Tilt range	100°(-10°~90°)	
Tilt speed	Max speed: 130°/sec,Manual speed: 0.065°/sec ~ 130°/sec	
Preset	500 presets	
Swing	8 swing patterns	
Pattern	4 patterns	
Group	8 groups	
Auto parking and auto-tracking	Yes	
<b>NETWORK</b>		
LAN	RJ45 (10/100Base-T)	RJ45 (10/100Base-T)
Video compression type	H.265, H.264, MJPEG	
Resolution	352x240 ~ 2304x1296	352x240 ~ 3840x2160
Frame rate	Max 60fps @ 2304x1296	Max 30fps @ 3840x2160
Video bitrate	Primary: 32Kbps ~ 16Mbps Secondary: 32Kbps ~ 4Mbps	
Bitrate control	H.264, H.265: CBR, VBR, Hybrid MJPEG: VBR	
Streaming capability	Quad streaming Primary: H.265, H.264 Secondary x 3: H.265, H.264, MJPEG	
IP	IPv4, IPv6	
Protocol	TCP, UDP, IGMP(Multicast), ICMP, DHCP, HTTP, HTTPS, FTP, SNMP, SMTP, UPnP, WS-Discovery, Zero Configuration, NTP, SRT, MPEG-TS, RTP, RTSP, RTMP, DDNS	
Security	Basic/Digest authentication, HTTPS, IP address filtering, user access log, TTA certification	
ONVIF conformance	Yes	
Web viewer	OS: Windows®, Mac® OS, Linux®	
	Browser: Internet Explorer®, Google Chrome®, Mozilla Firefox®, Safari®	
Video management software	DW Spectrum® IPVMS	
<b>ENVIRONMENTAL</b>		
Operating temperature	-22°F ~ 140°F (-30°C ~ 60°C)	
Operating humidity	0~90% RH (non-condensing)	
IK rating	IK10 impact-resistant	
IP rating	IP66-rated	

Other certifications	CE, FCC, RoHS, NDAA, TAA
ELECTRICAL	
Power requirement	PoE IEEE 802.3bt PoE++ Class7 (Adapter included)
Power consumption	75W, 1.363A
MECHANICAL	
Material	Aluminum die-casting
Dimensions	8.89" x 14.3" (226 x 364mm)
Weight	12.72 lbs (5.77 kg)
Warranty	2 year warranty



## Warranty Information

Go to <https://digital-watchdog.com/page/rma-landing-page/> to learn more about Digital Watchdog's warranty and RMA.

To obtain warranty or out-of-warranty service, please contact a technical support representative at:

1+ (866) 446-3595, from 9:00 AM to 8:00 PM EST, Monday through Friday.

A purchase receipt or other proof of the original purchase date is needed before warranty service is rendered. This warranty only covers failures due to defects in materials and workmanship that arise during normal use. This warranty does not cover damages that occur in shipment or failures that are caused by products not supplied by the Warrantor or failures that result from accident, misuse, abuse, neglect, mishandling, misapplication, alteration, modification, faulty installation, setup adjustments, improper antenna, inadequate signal pickup, maladjustments of consumer controls, improper operation, power line surge, improper voltage supply, lightning damage, rental use of the product or service by anyone other than an authorized repair facility or damage that is attributable to acts of God.

## Limits and exclusions

There are no express warranties except as listed above. The Warrantor will not be liable for incidental or consequential damages (including, without limitation, damage to recording media) resulting from using these products or arising out of any breach of the warranty. All express and implied warranties, including the warranties of merchantability and fitness for a particular purpose, are limited to the applicable warranty period set forth above.

Some states do not allow the exclusion or limitation of incidental or consequential damages or limitations on how long an implied warranty lasts, so the above exclusions or limitations may not apply to you. This warranty gives you specific legal rights; you may also have other rights from state to state.

If the problem is not handled to your satisfaction, then write to the following address:

Digital Watchdog, Inc.

ATTN: RMA Department

16220 Bloomfield Ave

Cerritos, CA 90703

Service calls that do not involve defective materials or workmanship as determined by the Warrantor, in its sole discretion, are not covered. The cost of such service calls is the responsibility of the purchaser.



*Complete Surveillance Solutions*

DW® East Coast office and warehouse: 5436 W Crenshaw St, Tampa, FL USA 33634  
DW® West Coast office and warehouse: 16220 Bloomfield Ave, Cerritos, CA USA 90703

PH: 866-446-3595 | FAX: 813-888-9262

[www.Digital-Watchdog.com](http://www.Digital-Watchdog.com)

[technicalsupport@digital-watchdog.com](mailto:technicalsupport@digital-watchdog.com)

Technical Support PH:

USA & Canada 1+ 866-446-3595

International 1+ 813-888-9555

French Canadian: + 1-904-999-1309

Technical Support Hours: Monday-Friday 9 a.m. to 8 p.m. Eastern Time